

# The Hubble Space Telescope Optical Systems Failure Report

---

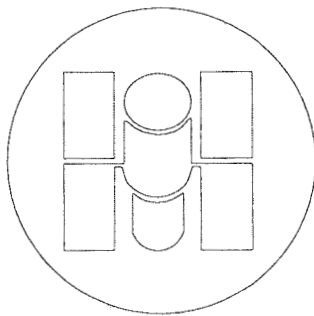

November 1990

**NASA**

National Aeronautics and  
Space Administration

(NASA-TM-103443) THE HUBBLE SPACE TELESCOPE  
OPTICAL SYSTEMS FAILURE REPORT (NASA)  
107 p CSCL 03A

N91-12437

Unclass  
0318179

G3/89

# The Hubble Space Telescope Optical Systems Failure Report

---

November 1990

**NASA**

National Aeronautics and  
Space Administration

**ORIGINAL CONTAINS  
COLOR ILLUSTRATIONS**

**THE HUBBLE SPACE TELESCOPE**  
**OPTICAL SYSTEMS FAILURE REPORT**



Dr. Lew Allen, Chairman  
Director, Jet Propulsion Laboratory

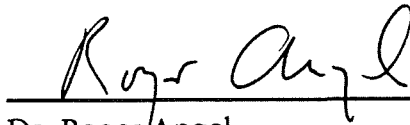

Dr. Roger Angel  
Professor of Astronomy, Steward Observatory  
University of Arizona

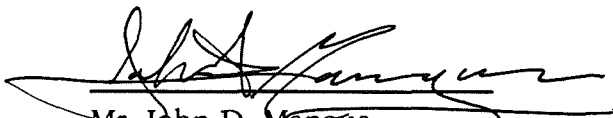

Mr. John D. Mangus  
Head, Optics Branch, Space Technology Division  
NASA/Goddard Space Flight Center



Mr. George A. Rodney  
Associate Administrator for Safety and Mission Quality  
NASA Headquarters

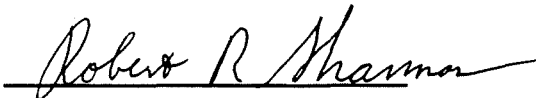

Professor Robert R. Shannon  
Director, Optical Sciences Center  
University of Arizona

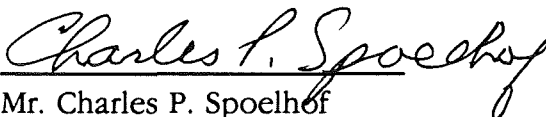

Mr. Charles P. Spoelhof  
Vice President (Retired), Eastman Kodak Company

## EXECUTIVE SUMMARY

The Hubble Space Telescope (HST) was launched aboard the Space Shuttle Discovery on April 24, 1990. During checkout on orbit, it was discovered that the telescope could not be properly focused because of a flaw in the optics. The HST Project Manager announced this failure on June 21, 1990. Both of the high-resolution imaging cameras (the Wide Field/Planetary Camera and the Faint Object Camera) showed the same characteristic distortion, called spherical aberration, that must have originated in the primary mirror, the secondary mirror, or both.

The National Aeronautics and Space Administration (NASA) Associate Administrator for the Office of Space Science and Applications then formed the Hubble Space Telescope Optical Systems Board of Investigation on July 2, 1990, to determine the cause of the flaw in the telescope, how it occurred, and why it was not detected before launch. The Board conducted its investigation to include interviews with personnel involved in the fabrication and test of the telescope, review of documentation, and analysis and test of the equipment used in the fabrication of the telescope's mirrors. The information in this report is based exclusively on the analyses and tests requested by the Board, the testimony given to the Board, and the documentation found during this investigation.

Continued analysis of images transmitted from the telescope indicated that most, if not all, of the problem lies in the primary mirror. The Board's investigation of the manufacture of the mirror proved that the mirror was made in the wrong shape, being too much flattened away from the mirror's center (a 0.4-wave rms wavefront error at 632.8 nm). The error is ten times larger than the specified tolerance.

The primary mirror is a disc of glass 2.4 m in diameter, whose polished front surface is coated with a very thin layer of aluminum. When glass is polished, small amounts of material are worn away, so by selectively polishing different parts of a mirror, the shape is altered. During the manufacture of all telescope mirrors there are many repetitive cycles in which the surface is tested by reflecting light from it; the surface is then selectively polished to correct any errors in its shape. The error in the HST's mirror occurred because the optical test used in this process was not set up correctly; thus the surface was polished into the wrong shape.

The primary mirror was manufactured by the Perkin-Elmer Corporation, now Hughes Danbury Optical Systems, Inc., which was the contractor for the Optical Telescope Assembly. The critical optics used as a template in shaping the mirror, the reflective null corrector (RNC), consisted of two small mirrors and a lens. The

RNC was designed and built by the Perkin-Elmer Corporation for the HST Project. This unit had been preserved by the manufacturer exactly as it was during the manufacture of the mirror. When the Board measured the RNC, the lens was incorrectly spaced from the mirrors. Calculations of the effect of such displacement on the primary mirror show that the measured amount, 1.3 mm, accounts in detail for the amount and character of the observed image blurring.

No verification of the reflective null corrector's dimensions was carried out by Perkin-Elmer after the original assembly. There were, however, clear indications of the problem from auxiliary optical tests made at the time, the results of which have been studied by the Board. A special optical unit called an inverse null corrector, designed to mimic the reflection from a perfect primary mirror, was built and used to align the apparatus; when so used, it clearly showed the error in the reflective null corrector. A second null corrector, made only with lenses, was used to measure the vertex radius of the finished primary mirror. It, too, clearly showed the error in the primary mirror. Both indicators of error were discounted at the time as being themselves flawed.

The Perkin-Elmer plan for fabricating the primary mirror placed complete reliance on the reflective null corrector as the only test to be used in both manufacturing and verifying the mirror's surface with the required precision. NASA understood and accepted this plan. This methodology should have alerted NASA management to the fragility of the process and the possibility of gross error, that is, a mistake in the process, and the need for continued care and consideration of independent measurements.

The design of the telescope and the measuring instruments was performed well by skilled optical scientists. However, the fabrication was the responsibility of the Optical Operations Division at the Perkin-Elmer Corporation (P-E), which was insulated from review or technical supervision. The P-E design scientists, management, and Technical Advisory Group, as well as NASA management and NASA review activities, all failed to follow the fabrication process with reasonable diligence and, according to testimony, were unaware that discrepant data existed, although the data were of concern to some members of P-E's Optical Operations Division. Reliance on a single test method was a process which was clearly vulnerable to simple error. Such errors had been seen in other telescope programs, yet no independent tests were planned, although some simple tests to protect against major error were considered and rejected. During the critical time period, there was great concern about cost and schedule, which further inhibited consideration of independent tests.

The most unfortunate aspect of this HST optical system failure, however, is that the data revealing these errors were available from time to time in the fabrication

process, but were not recognized and fully investigated at the time. Reviews were inadequate, both internally and externally, and the engineers and scientists who were qualified to analyze the test data did not do so in sufficient detail. Competitive, organizational, cost, and schedule pressures were all factors in limiting full exposure of all the test information to qualified reviewers.

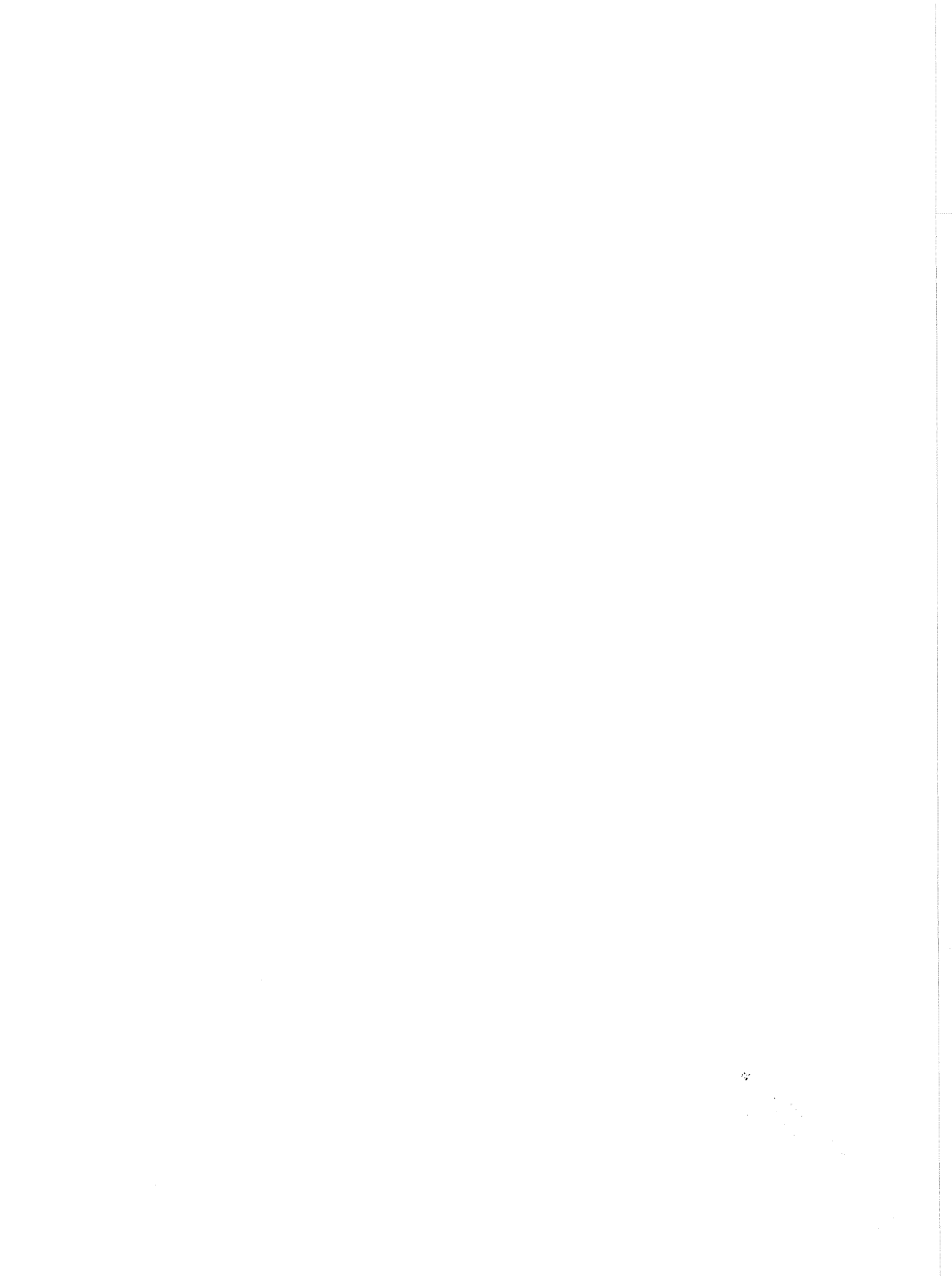

## CONTENTS

I	INTRODUCTION	1-1
II	THE HUBBLE SPACE TELESCOPE MISSION	2-1
III	PROGRAM HISTORY AND MANAGEMENT	3-1
	A. Responsibilities	3-1
	B. Environment	3-4
IV	OPTICAL TELESCOPE ASSEMBLY	4-1
	A. HST Optical Design	4-1
	B. Optical Testing	4-1
	C. Null Correctors and Optics	4-1
	D. Polishing	4-6
	E. Final Tests	4-7
V	THE FAILURE	5-1
VI	IDENTIFICATION OF THE FAILURE	6-1
	A. Onboard Data	6-1
	B. Sources of Error	6-2
VII	HOW THE ERROR OCCURRED	7-1
	A. Introduction	7-1
	B. Metering Rod Measurements	7-1
VIII	QUALITY ASSURANCE OBSERVATIONS	8-1
IX	WHY THE ERROR WAS NOT DETECTED PRIOR TO FLIGHT	9-1
	A. Factual Statements	9-1
	B. Judgmental Statements	9-2
X	LESSONS LEARNED	10-1
	A. Identify and Mitigate Risk	10-1
	B. Maintain Good Communication Within the Project	10-2
	C. Understand Accuracy of Critical Measurements	10-2
	D. Ensure Clear Assignment of Responsibility	10-3
	E. Remember the Mission During Crisis	10-4
	F. Maintain Rigorous Documentation	10-4
	GLOSSARY	11-1



APPENDIX A	CHARTER AND MEMBERSHIP OF THE BOARD	A-1
APPENDIX B	SUMMARY OF PROCEEDINGS	B-1
	Attachment 1 HST Independent Optical Review Panel Findings	B-1-1
APPENDIX C	TUTORIAL ON SPHERICAL AND COMA ABERRATION	C-1
	A. Introduction	C-1
	B. Spherical Aberration	C-1
	C. Correcting for Spherical Aberration	C-3
	D. Field of View	C-3
	E. Coma Aberration	C-4
	F. Correcting Coma and Spherical Aberrations Across the Field	C-4
APPENDIX D	DESCRIPTIVE SUMMARY OF INTERFEROGRAMS	D-1
	A. Final Test of the Primary Mirror	D-1
	B. Refractive Null Corrector Test of the Primary Mirror	D-5
	C. Inverse Null Corrector Fringes	D-6
	D. Secondary Mirror Test Interferogram	D-11
APPENDIX E	HST PERFORMANCE BASED ON AS-BUILT DATA	E-1

#### Tables

2-1.	HST scientific instrument specifications.	2-3
E-1.	HST OTA paraxial design parameters.	E-2
E-2.	HST OTA paraxial as-built parameters.	E-3

#### Figures

2-1.	Optical Telescope Assembly.	2-2
3-1.	Hubble Space Telescope responsibilities.	3-2
3-2.	MSFC's Hubble Space Telescope responsibilities.	3-3
4-1.	Two-element refractive null corrector.	4-3
4-2.	Reflective null corrector.	4-4
4-3.	Inverse null corrector inserted below the reflective null corrector.	4-5
5-1.	Encircled energy versus arcsecond radius of image produced by the HST.	5-2

6-1.	Planetary Camera images versus computer simulations.	6-3
6-2.	Comparison of 1982 and 1990 inverse null corrector data.	6-8
6-3.	The 1990 spacing measurement between the field lens and the lower mirror of the reflective null corrector, using an optical test.	6-10
6-4.	The 1990 spacing measurement between the lower mirror vertex and the field lens of the reflective null corrector, using a mechanical technique.	6-12
7-1.	Position of metering rods used to space optical elements in the reflective null corrector.	7-2
7-2.	Metering rod (B rod) used to space the field lens and the center of curvature of the lower mirror in the reflective null corrector.	7-3
7-3.	Metering rod in position between the field lens and the center of curvature of the lower mirror in the reflective null corrector.	7-5
7-4.	Displacement due to the interferometer focusing on the field cap instead of the metering rod.	7-8
7-5.	Top view of the field cap, showing the aperture and the area where the antireflective coating had broken away.	7-9
C-1.	Light-path comparison between spheric and aspheric mirrors.	C-2
C-2.	Image distortion due to spherical and coma aberration.	C-5
C-3.	The HST's Ritchey-Chretien optical system.	C-7
C-4.	Image-plane enlargement of the HST Ritchey-Chretien optical system.	C-8
D-1.	RNC interferogram of the primary mirror, taken in February 1982.	D-3
D-2.	RvNC interferogram of the primary mirror, taken in May 1981.	D-7
D-3.	INC interferogram of the reflective null corrector, taken in February 1981.	D-9
D-4.	Hindle Shell interferogram of the secondary mirror, taken August 31, 1981.	D-13

# CHAPTER I

## INTRODUCTION

The rough grinding operation for the Hubble Space Telescope began in December 1978, at the Perkin-Elmer Corporation, in Wilton, Connecticut. The mirror was then transferred to Perkin-Elmer in Danbury, Connecticut, now Hughes Danbury Optical Systems, Inc. (HDOS), where polishing was completed in April 1981, and the mirror was accepted as ready for reflective coating. The final post-coating test was made in February 1982.

Approximately two months after launch, on June 21, 1990, the Hubble Space Telescope Project Manager announced that there was a major flaw in one or both of the mirrors in the Optical Telescope Assembly. Dr. Lennard Fisk, Associate Administrator for the Office of Space Science and Applications, in accordance with the procedures of the HST Contingency Plan, established the Hubble Space Telescope Optical Systems Board of Investigation to determine the relevant facts. A copy of the Board's charter, incorporated in a letter of authorization to the Chairman, and a list of the members of the Board are presented in Appendix A of this report.

The Board, in accordance with its charter, impounded all relevant documentation and equipment at the HDOS facility. With the assistance of HDOS personnel and NASA HST Project and Program management, the Board reviewed documents, interviewed personnel, and analyzed and tested the equipment used during the fabrication of the mirrors.

The first meeting of the Board was held in Washington, DC on July 5 and 6, 1990, and the subsequent meetings were held at HDOS. A summary of all the Board meetings and attendees can be found in Appendix B.

The investigation was quickly directed to the fabrication and testing of the primary mirror. The test equipment used during the final shaping and polishing of the primary mirror was found in 1990 in essentially the same configuration as it had been when used in 1980 through 1982.

Another investigating body, the Independent Optical Review Panel, was formed by the HST Project to examine the on-orbit data and recommend actions to maximize the scientific utility of the HST. One of the principal concerns of the Independent Optical Review Panel is the impact of the spherical aberration discovered in the HST primary mirror. The results and findings of the HST Optical Systems Board of Investigation will undoubtedly assist the Independent Optical

Review Panel in its work. (An early report of the Panel's findings is included in Appendix B.)

This report of the Board's investigation describes the results of the analysis and test of the equipment used during fabrication and sets forth the conclusions which can be drawn. It is difficult to reconstruct the exact events of the time, particularly since the status of the documentation is poor. It is also difficult to consider fairly the pressures of the time in question when cost and schedule were issues of crisis proportions. Therefore, the Board's judgments clearly benefit from hindsight, with the clear knowledge that an error occurred and should not have occurred.

## CHAPTER II

### THE HUBBLE SPACE TELESCOPE MISSION

The HST was designed to be the first of the great space observatories. It was launched aboard the Space Shuttle and placed in an Earth orbit approximately 607 kilometers in altitude. The expected life of the telescope is about 15 years, with instrument changeouts every 3 to 5 years.

The goal of the mission is to extend our knowledge of the universe. A space-based telescope has the advantage of being in an environment free of the turbulence and absorption of the Earth's atmosphere. Prior to this mission, astronomical telescopes in space, such as the Einstein Observatory (HEAO-2) and the Infrared Astronomical Satellite (IRAS), had been designed to explore new wavelength bands not transmitted through the atmosphere. The HST was the first space telescope designed to overcome the blurring of images caused by the atmosphere. The inherent resolution of a precisely made telescope is in proportion to its diameter, and the large 2.4-m aperture of HST promised images ten times sharper than the best images from the ground.

At the heart of the Optical Telescope Assembly (OTA) is a 2.4-m Ritchey-Chretien telescope with a focal ratio of  $f/24$ . The optical range of the HST extends from 1,100 to 11,000 angstroms, and the performance quality in the ultraviolet is unique. Figure 2-1 illustrates the OTA.

Eight instrument packages are attached to the HST: two cameras (Wide Field/Planetary Camera and Faint Object Camera), two spectrographs (Faint Object Spectrograph and High-Resolution Spectrograph), one photometer (High-Speed Photometer), and three fine guidance sensors. Each fine guidance sensor package also contains a wavefront sensor. Table 2-1 lists the HST and scientific instrument specifications.

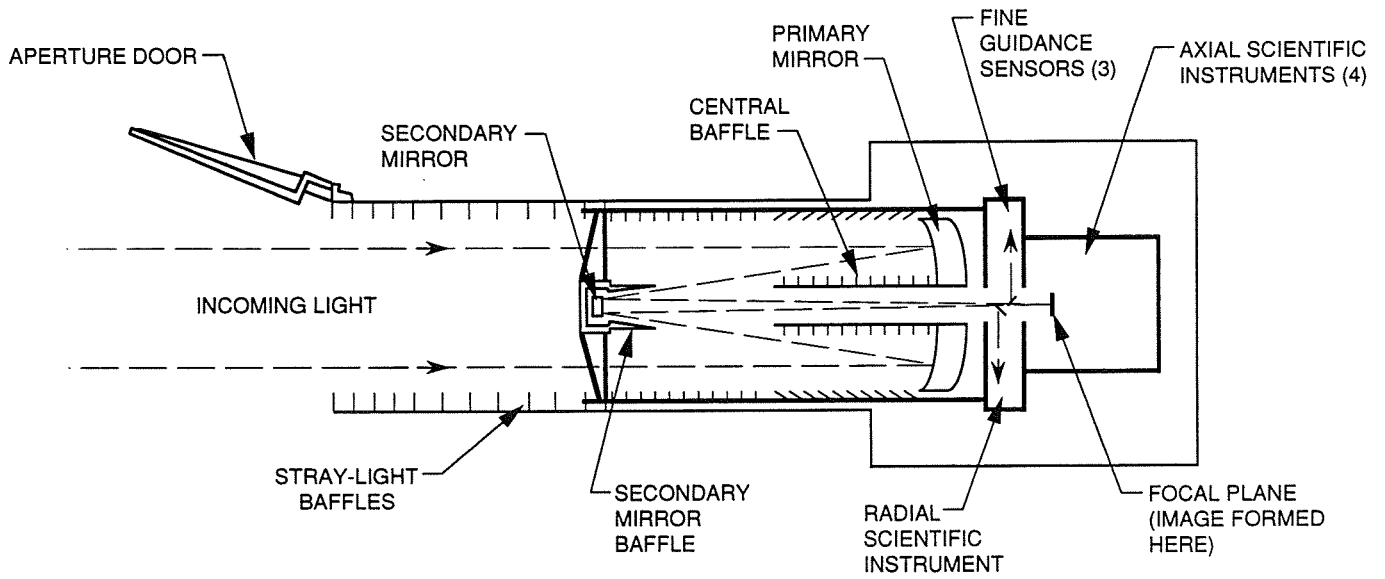

**Figure 2-1. Optical Telescope Assembly.**

**Table 2-1. HST scientific instrument specifications.**

Hubble Space Telescope	
Weight	11,500 kg
Length	13 m
Diameter	4.2 m at widest
Optical System	Ritchey-Chretien design Cassegrain telescope
Optical Length	57.6 m folded to 6.4 m
Primary Mirror	2.4 m in diameter
Secondary Mirror	0.3 m in diameter
Field of View	See instruments and sensors below
Pointing Accuracy	0.007 arcsec for 24 hr
Magnitude Range	5-29 $m_v$
Wavelength Range	1,100-11,000 angstroms
Angular Resolution	0.1 arcsec at 6,328 angstroms
Orbit	611 km (330 nmi) inclined 28.5° from equator
Orbit Time	94 minutes per orbit
Mission	15 years
Faint Object Camera	
Weight	315 kg
Dimensions	0.9 x 0.9 x 2.2 m
Principal Investigator	F. D. Macchetto, European Space Agency (ESA)
Contractor	ESA (Dornier, Matra Corp.)
Optical Modes	f/96, f/48
Field of View	11.2, 22 arcsec <sup>2</sup>
Magnitude Range	5-28 $m_v$
Wavelength Range	1,150-6,500 angstroms
Wide Field/Planetary Camera	
Weight	268 kg
Dimensions	Camera: 1 x 1.3 x 0.5 m Radiator: 0.8 x 2.2 m
Principal Investigator	J. A. Westphal, California Institute of Technology
Contractor	Jet Propulsion Laboratory
Optical Modes	f/12.9 (WF); f/30 (P)
Field of View	160, 66 arcsec <sup>2</sup>
Magnitude Range	9-28 $m_v$
Wavelength Range	1,150-11,000 angstroms
GSFC High-Resolution Spectrograph	
Weight	315 kg
Dimensions	0.9 x 0.9 x 2.2 m
Principal Investigator	J. C. Brandt, NASA/Goddard Space Flight Center
Contractor	Ball Aerospace
Apertures	2 arcsec <sup>2</sup> target, 0.25 arcsec <sup>2</sup> science
Resolution	2,000-100,000
Magnitude Range	17-11 $m_v$
Wavelength Range	1,050-3,200 angstroms

**Table 2-1. HST scientific instrument specifications (continued).**

Faint Object Spectrograph	
Weight	306 kg
Dimensions	0.9 x 0.9 x 2.2 m
Principal Investigator	R. J. Harms, NASA/Ames Research Center
Contractor	Martin Marietta Corporation
Apertures	0.1–4.3 arcsec <sup>2</sup>
Resolution	250, 1,300
Magnitude Range	19–26 m <sub>v</sub>
Wavelength Range	1,100–8,000 angstroms
High-Speed Photometer	
Weight	270 kg
Dimensions	0.9 x 0.9 x 2.2 m
Principal Investigator	R. Bless, University of Wisconsin
Contractor	University of Wisconsin
Apertures	0.4, 1.0, 10.0 arcsec <sup>2</sup>
Resolution	Filter-defined
Magnitude Range	<24 m <sub>v</sub>
Wavelength Range	1,200–7,500 angstroms
Fine Guidance Sensors	
Weight	218 kg
Dimensions	0.5 x 1 x 1.6 m
Contractor	Perkin-Elmer Corporation
Astrometric Modes	Stationary and moving target, scan
Precision	0.002 arcsec <sup>2</sup>
Measurement Speed	10 stars in 10 minutes
Field of View	Access: 60 arcmin <sup>2</sup> Detect: 5 arcsec <sup>2</sup>
Magnitude Range	4–18.5 m <sub>v</sub>
Wavelength Range	4,670–7,000 angstroms

Information provided by Lockheed Missiles and Space Company, Inc.



## **CHAPTER III**

### **PROGRAM HISTORY AND MANAGEMENT**

#### **A. RESPONSIBILITIES**

The HST program is the result of a cooperative effort between NASA and the European Space Agency, private contractors, and astronomers worldwide. The management responsibilities included design, development, launch, and daily operations of the telescope. The NASA Centers and prime contractors involved in the development of the HST, and their interrelationships, are listed in Figure 3-1.

At NASA Headquarters, the director of the Astrophysics Division, who reports to the NASA Associate Administrator for the Office of Space Science and Applications, has overall authority for the HST Project. He assigned the NASA HST Program Manager to ensure that NASA policies and Project goals are maintained and to administer the schedule and budget. Overall science policy is the responsibility of the HST Program Scientist.

Marshall Space Flight Center (MSFC) was assigned as lead center for the HST Project management and tasked with the development of the telescope flight hardware and the general checkout phase after deployment. Responsibility for meeting the technical performance goals and for managing the program within budget and schedule was also with MSFC. Figure 3-2 is the MSFC organization chart for the HST.

The other NASA Center with a major involvement in the Project is the Goddard Space Flight Center (GSFC), which was responsible for verifying the performance of the science instruments. GSFC also controls the daily operations of the HST. On October 16, 1990, the responsibility for the HST Project (except for the optical system failure questions) was transferred from MSFC to GSFC.

The two prime contractors for the Project were Lockheed Missiles and Space Company, Inc. (LMSC) and the Perkin-Elmer Corporation (P-E). LMSC developed the Support Systems Module (SSM) and supervised many subcontracts; P-E designed and developed the OTA, including the fabrication of the primary and secondary mirrors. P-E was also responsible for verification testing and delivery of the OTA to LMSC, where the OTA was integrated with the other subsystems. In addition to the OTA, P-E developed the fine guidance sensors and wavefront sensors used in the HST.

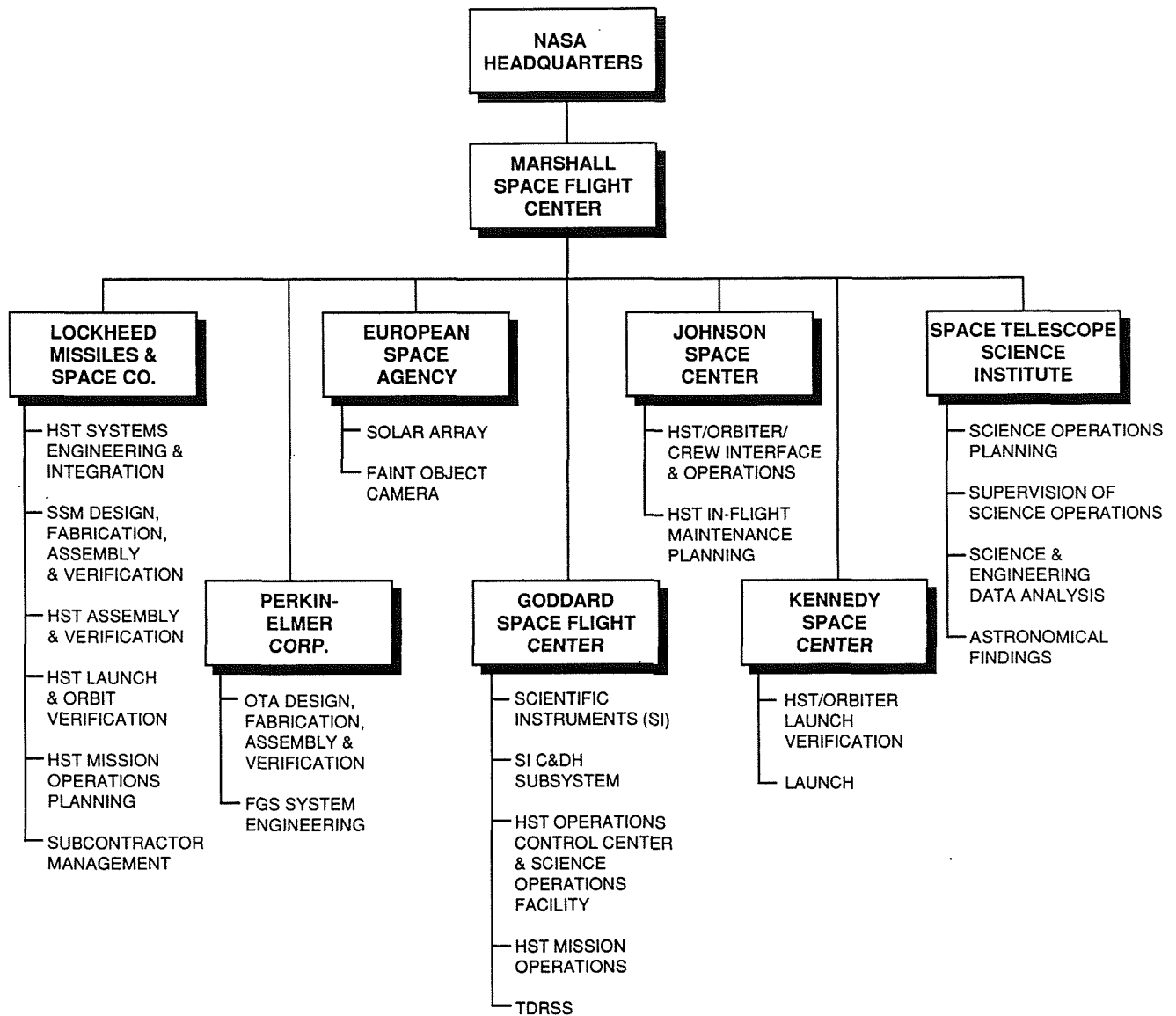

INFORMATION PROVIDED BY LOCKHEED MISSILES AND SPACE COMPANY, INC.

**Figure 3-1. Hubble Space Telescope responsibilities.**

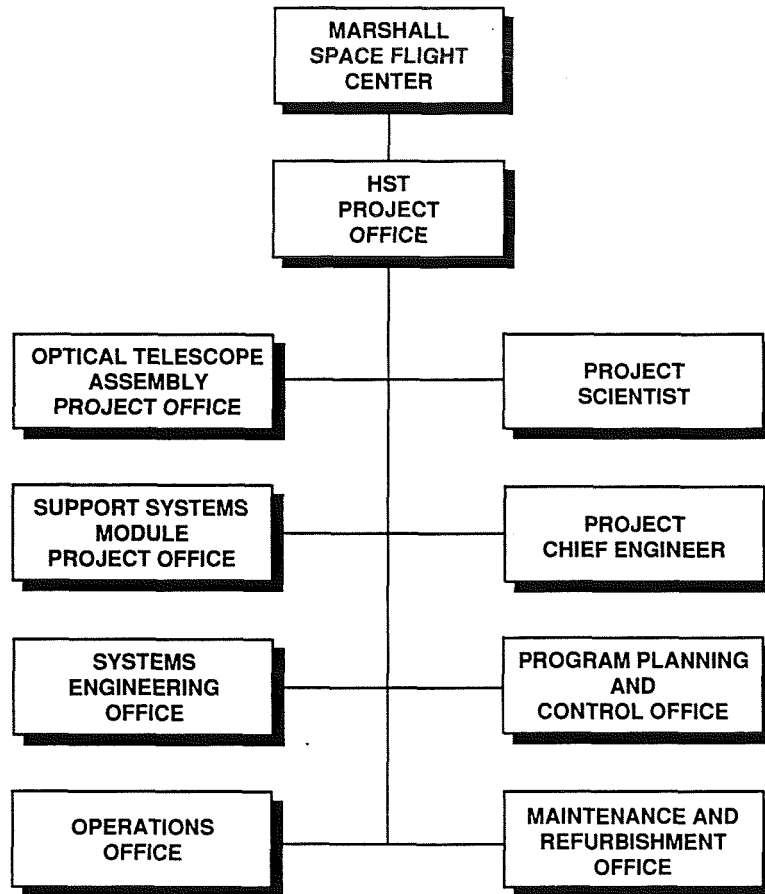

**MSFC RESPONSIBILITIES**

- HST DEVELOPMENT LEAD CENTER
- TOTAL PROJECT MANAGEMENT
- OTA DEVELOPMENT
- SSM DEVELOPMENT
- HST INTEGRATION AND VERIFICATION
- ORBITAL VERIFICATION OPERATIONS
- MAINTENANCE AND REFURBISHMENT PLANNING

INFORMATION PROVIDED BY LOCKHEED MISSILES AND SPACE COMPANY, INC.

**Figure 3-2. MSFC's Hubble Space Telescope responsibilities.**

Before P-E was selected as the OTA prime contractor, the company was asked to design and build a smaller hyperbolic mirror in order to demonstrate their technical capability. A 1.5-m mirror was successfully designed, fabricated, and tested using the new technologies that would be used for the larger 2.4-m HST primary mirror. After a competitive bid process, P-E was awarded the HST contract, based in part on their successful demonstration of the 1.5-m mirror and on other factors, including their proposed fine guidance sensors.

Because NASA considered the quality of the primary mirror to be a major challenge, it directed P-E to subcontract with the Eastman Kodak Company to fabricate a second primary mirror. The fabrication and test methods used at Eastman Kodak and P-E were entirely different. It was the responsibility of NASA to review the final specifications of the mirrors and to choose the best one for flight. The P-E primary and secondary mirrors were selected.

## **B. ENVIRONMENT**

During 1981 and continuing through early 1982, the HST program was beset by many difficulties. The estimated cost of the P-E contract had increased several-fold and the schedule had slipped substantially. The fine guidance sensors were having serious technical problems, and the severity of the challenge to keep the mirrors sufficiently free from contamination to meet the specifications in ultraviolet light was just being recognized. The program was threatened with cancellation, and management ability was questioned. All these factors appear to have contributed to a situation where NASA and P-E management were likely to be distracted from supervision of mirror fabrication.

## **CHAPTER IV**

### **OPTICAL TELESCOPE ASSEMBLY**

#### **A. HST OPTICAL DESIGN**

The Optical Telescope Assembly in the Hubble Space Telescope is a two-mirror reflecting telescope very similar to most Earth-based telescopes built in the last 75 years. These two-mirror telescopes are generally referred to as Cassegrain telescopes, after the French cleric who first published the design. The OTA is a special type of Cassegrain telescope called a Ritchey-Chretien (R-C) that has better optical performance over a larger format in the image plane. The mirrors in the R-C are slightly more aspheric (have a greater departure from a pure spherical shape) than in the Cassegrain type, but both types of telescopes are quite common. The primary mirror in the OTA, the one in which the error exists, is a 2.4-m diameter concave hyperboloid. The 0.3-m diameter secondary mirror is a convex hyperboloid. This makes the OTA a little less than half the size of the Hale telescope on Mt. Palomar.

#### **B. OPTICAL TESTING**

Spherical mirrors are easy to make and to test, but such mirrors do not produce good-quality images. The aspheric mirrors used in Cassegrain or R-C telescopes can produce theoretically perfect images, but their aspheric shape makes them difficult to test. Because the two mirrors in the OTA are hyperboloids or aspheric mirrors, special test optics are needed to guarantee that the mirrors are the correct shape. These special test optics, called null correctors, generate test reference wavefronts that make the aspheric mirror look spherical to the optician. The null correctors achieve this effect by projecting an optical template of the desired aspheric shape that can be designed to be accurate to better than 25 nanometers.

#### **C. NULL CORRECTORS AND OPTICS**

The convex secondary mirror of the OTA was tested in a geometrically perfect null test with what is called a Hindle Shell test, a modification of the classic Hindle Sphere test. Because hyperboloids have the property of perfectly imaging rays from one focus into the other focus, the Hindle Shell null corrector is used to physically implement this test. The Hindle test of the OTA secondary was carried out precisely as planned, and the shape of this mirror met specification. The

aspheric shape of the secondary mirror was verified through the use of two independent tests during fabrication of the component.

In the manufacture of prior telescopes, refractive null correctors (RvNCs), such as the one shown in Figure 4-1, were used. The combination of the two precisely made and spaced lenses produces the desired optical template of the concave aspheric mirror.

Carrying out an unambiguous and accurate test to determine whether a null corrector is producing the correct optical template is a known difficulty. For the HST program, Perkin-Elmer concluded that an RvNC would not yield sufficient precision for testing the figure of the primary mirror, and as a result, a new and novel reflective null corrector (RNC) was designed. As shown in Figure 4-2, the Perkin-Elmer RNC consists of two spherical mirrors and one small field lens. (The more common RNC design contains only a single mirror and a field lens.) In the P-E design, the shape of the optical template could be precisely predicted simply by knowing the manufactured dimensions of the two mirrors and the lens, including the lens material, and the spacings of the three optical elements. Perkin-Elmer planned to certify the RNC with great care, and they did not plan to do any independent testing of the mirror.

The RNC was designed to provide easy access to all the optical surfaces in the null corrector in order to measure these spacings at any time. The spacing between the two spherical mirrors can be measured by determining the distance between the centers of curvature of the two mirrors. This measurement is done interferometrically, using a known metering rod of the desired length. In a similar manner, the field lens spacing can be measured relative to the center of curvature of the lower mirror. The spacings need to be correct to 10  $\mu\text{m}$  to meet specifications.

This ability to measure the optical element spacings at any time is something that is not possible with a traditional RvNC, made up of all lenses and no mirrors. The novel RNC that answered some of the misgivings about the RvNC approach was one of the factors leading to the award of the HST contract to Perkin-Elmer.

As a check on the position of the Coaxial Reference Interferometer (CORI) used with the RNC, an inverse null corrector (INC) was designed. When swung under the RNC, the INC would simulate a perfect mirror, just as a perfect primary mirror would appear with straight fringes when viewed through the RNC (Figure 4-3).

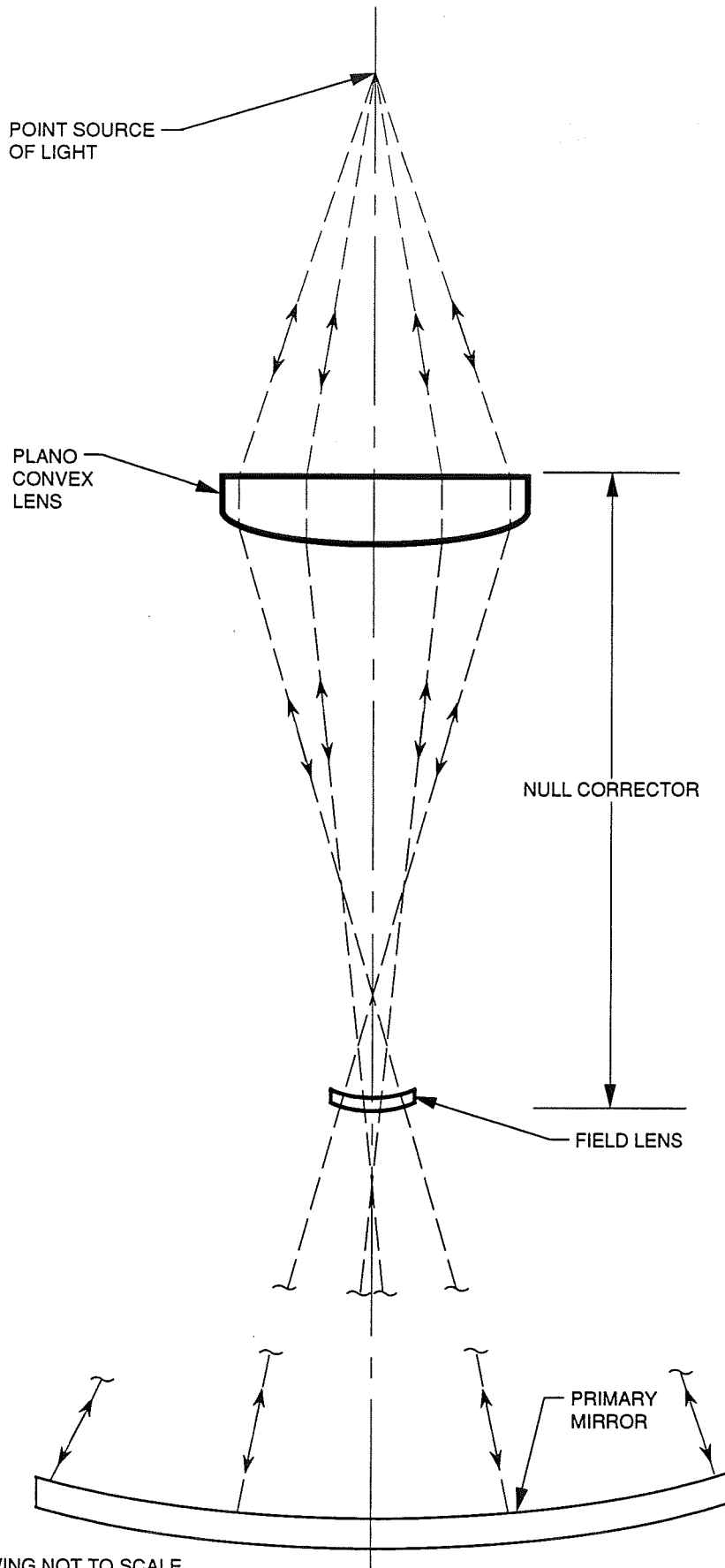

NOTE: THIS DRAWING NOT TO SCALE

**Figure 4-1. Two-element refractive null corrector.**

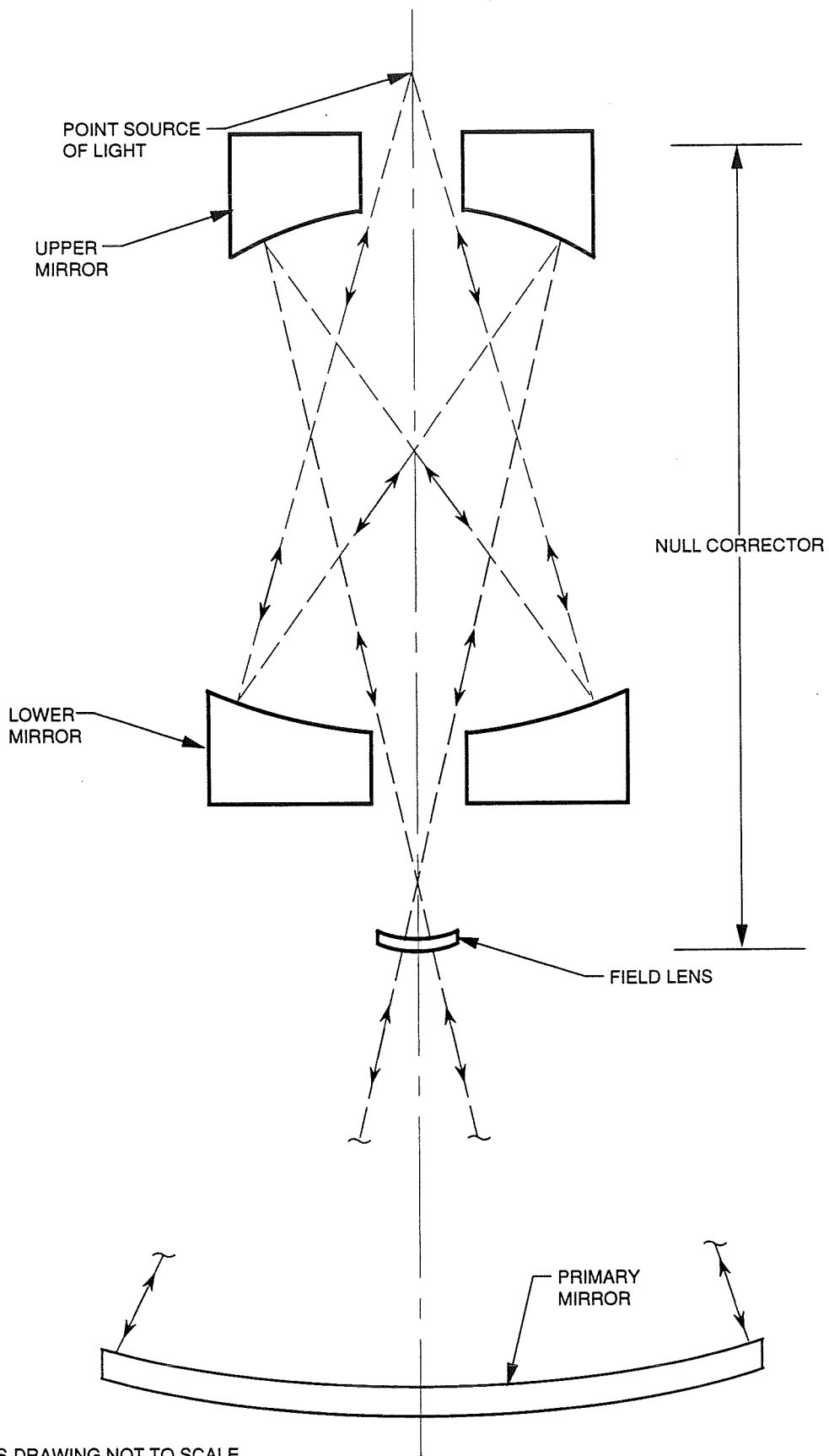

NOTE: THIS DRAWING NOT TO SCALE

Figure 4-2. Reflective null corrector.



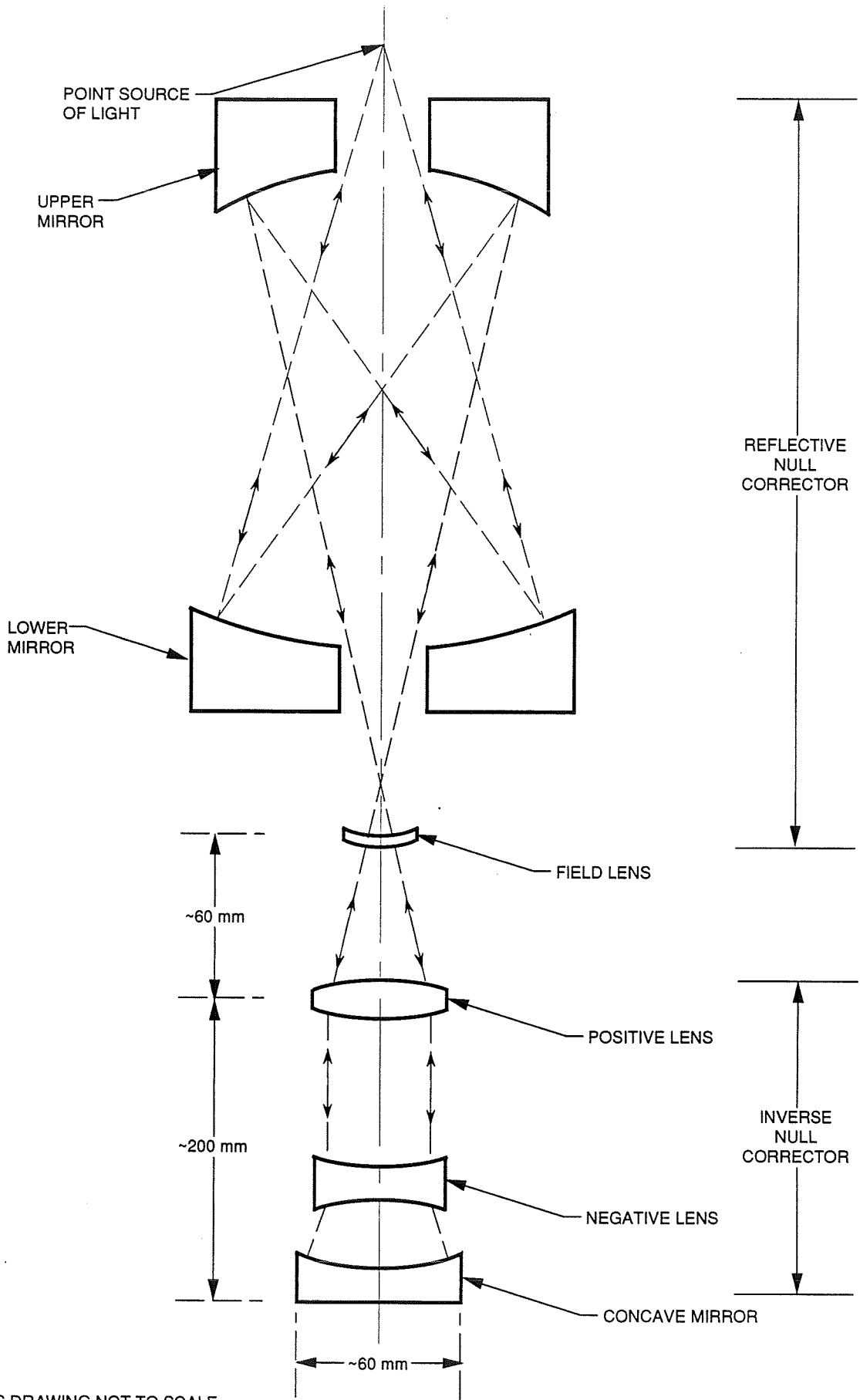

NOTE: THIS DRAWING NOT TO SCALE

**Figure 4-3. Inverse null corrector inserted below the reflective null corrector.**

Although not considered as a backup or additional check of the optical template produced by the RNC, an RvNC was built to test the OTA primary during early stages of polishing and was again used to test the primary mirror during a measurement of the vertex radius of curvature or "power" of the primary mirror. The RvNC had to be used for this radius measurement because the RNC had to have central holes in the two mirrors (just as the primary had a hole) to let the light through. Because of the holes in the RNC mirrors, it was not possible to see the location of the vertex of the primary mirror.

"White-light" fringes were used as an initial setup procedure to align the reference test plate (i.e., the calibrated mirror inserted into the hole of the primary mirror) for the vertex radius measurement. This measurement was extremely sensitive to vibration, and the fringes could not be captured on film because of the short duration and faintness of the images. Several observers were required to witness that the fringes were seen. When this test was accomplished, a helium-neon (He-Ne) laser replaced the white-light source in order to take photographs (interferograms) by which to make the vertex radius measurement.

#### **D. POLISHING**

During the polishing of the OTA mirrors, the Hindle test was performed on the secondary mirror, and its surface was polished until it looked like a pure sphere to about 0.012-wave rms wavefront error at 632.8 nm. This meant that the surface was the correct hyperboloid to this same quality, a quality better than that specified in the contract.

The backup OTA primary mirror was polished at Eastman Kodak Company using both a refractive and a reflective null corrector of a completely different design from the Perkin-Elmer version. This mirror matched the templates of the two null correctors to better than 0.014-wave rms wavefront error at 632.8 nm, and the Board has every reason to believe it is the correct hyperboloidal shape.

The primary mirror now flying in the HST was polished using the Perkin-Elmer RNC as a guide or template. Again, the fit to the template was better than 0.014-wave rms wavefront error at 632.8 nm, better than the contract specification for the accuracy of the mirror. Unfortunately, as has been subsequently learned, there was an error in the template produced by the RNC, thus making the primary mirror the wrong shape.

## E. FINAL TESTS

An end-to-end test of the OTA would have been very expensive to perform at the level of accuracy specified for the telescope. The test would have cost on the order of what the OTA itself cost, because a flat or plano mirror would have been needed. To test the flat mirror by a single interferogram would have required a spherical mirror about 15 percent larger than the flat mirror. Thus the test could have required two additional mirrors as large as or larger than the OTA primary.

In hindsight, a much less severe test could have been done to check for a gross error such as did occur. The belief at the time was that if the two mirrors had each exceeded their individual specifications, only a test at the level of accuracy of the individual mirrors would have been meaningful. Such a test would have been very hard to justify because of cost.

Actually, an end-to-end test was done over a 0.3-m diameter aperture to ensure that the assembled telescope focused where it should. There was no attempt to use this test as a check on the figure of the primary mirror, apparently because it was believed that the fraction of the mirror tested was too small to give reliable results and also because the OTA was mounted horizontally and the distortion due to gravity was significant.

## CHAPTER V

### THE FAILURE

The Level I specification for the HST is to achieve 70 percent encircled energy in a circle of 0.1-arcsecond radius and to meet a Rayleigh criterion (i.e., image resolution of two objects) of at least 0.1 arcsecond. Early in the checkout phase of the mission, it was discovered that the telescope did not meet the above requirement. Instead, the telescope focused 70 percent encircled energy into a 0.7-arcsecond radius. Figure 5-1 is a plot of the encircled energy percentage versus radius in arcseconds for both the specified HST performance and the actual performance.

The problem was initially detected when the "first light" images from both the Wide Field/Planetary Camera and the Faint Object Camera were analyzed and major defects were detected. Computer simulation of these images indicated that 0.5-wave rms wavefront spherical aberration at 547 nm existed in the telescope and not in the instruments. Further verification of the spherical aberration problem came from the wavefront sensors.

Both on-axis and off-axis data were analyzed in order to determine whether the primary mirror or the secondary mirror, or perhaps both mirrors, were flawed. Data taken by the wavefront sensors, the Wide Field/Planetary Camera, and the Faint Object Camera indicated a significant spherical aberration wavefront error. Although some coma appeared in the off-axis results taken by the fine guidance sensors, the amount of coma was small and the conclusion was reached that the primary source of image spreading is spherical aberration of the primary mirror.

Spherical aberration distorts a point source image (e.g., a distant star) by broadening the image and surrounding it with concentric diffraction rings. This broadening effect prevents distant, closely spaced objects from being separated in the image. A tutorial on spherical and coma aberration is given in Appendix C.

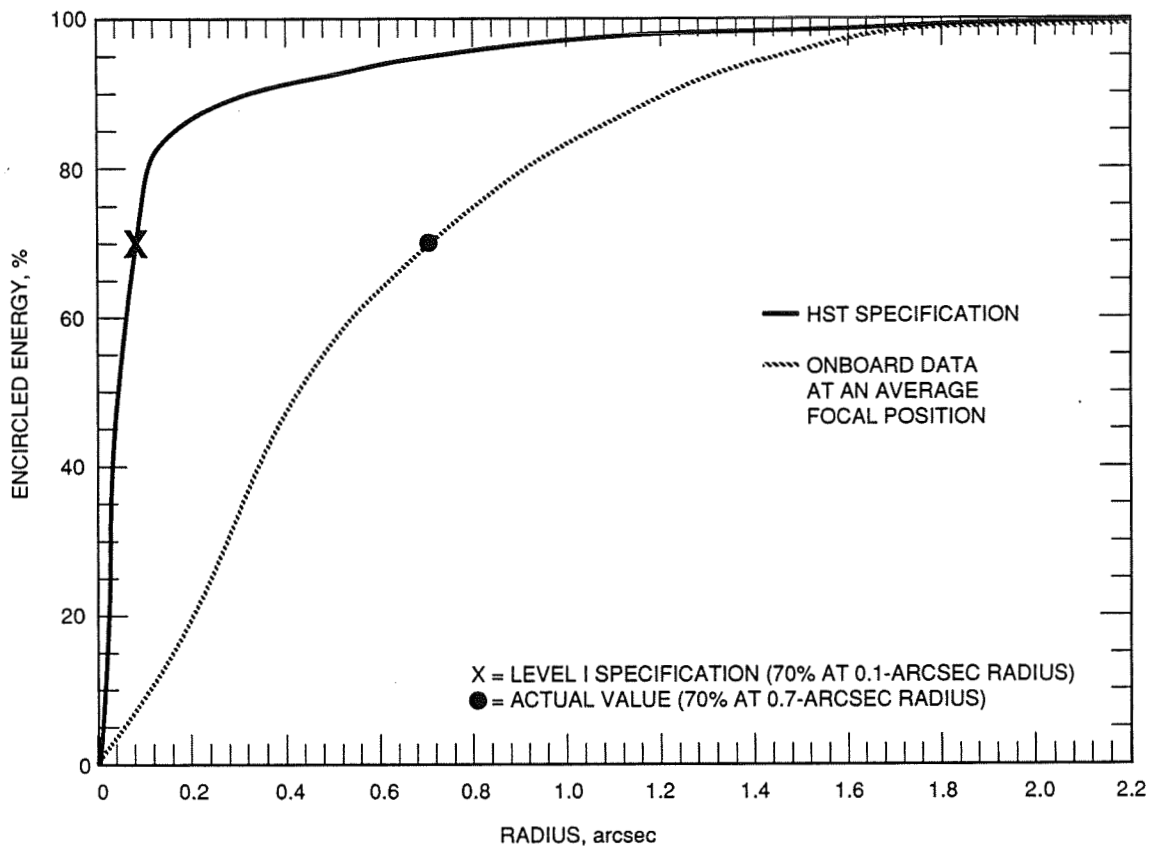

**Figure 5-1. Encircled energy versus arcsecond radius of image produced by the HST.**

## CHAPTER VI

### IDENTIFICATION OF THE FAILURE

#### A. ONBOARD DATA

The first step in focusing the HST requires the onboard pointing control system (PCS) to position the telescope at a known pattern of stars that are imaged into the three fine guidance sensors (FGS). Once this pattern of stars is locked onto by the FGS, the secondary mirror is moved along the axis of symmetry in order both to ensure that the mirror is moving in the correct direction and to obtain an accurate estimate of where the best focus is located. It was a NASA policy that first light images would not be recorded until after the best focus had been obtained using the FGS.

Several problems occurred early in the checkout phase. The PCS was hindered by the thermal environment at the terminator (where the HST passes from Earth shadow to sunlight and vice versa), which induced a mechanical distortion in the solar array structure, in turn causing pointing difficulties. In addition, the HST's star trackers executed several improper star acquisitions, causing the telescope to be pointed in the wrong direction; only three of the first 16 star acquisitions were successful. Both these effects severely complicated the focusing activity.

After a position for the secondary mirror was selected for first light, the Wide Field/Planetary Camera (WF/PC) recorded its first image. The initial image analysis indicated significant defects. Since the secondary mirror had only been moved along the axis of symmetry, it was still believed at the time that corrections could be made by tilting or decentering the mirror to improve the focus.

The next portion of the checkout involved using the wavefront sensors (WFS), which are more sensitive than the FGS, to precisely analyze the errors in the optical wavefront. Deviations from a perfect incoming shape could then be precisely determined and quantified. Such deviations can take on any geometrical shape and are classified as alignment errors or optical aberrations such as astigmatism, spherical aberration, and coma.

The secondary mirror was again moved along the axis of symmetry, and the wavefront was analyzed by the WFS. At the same time, star images were made with the WF/PC. Both the WFS and the WF/PC indicated that a large amount of spherical aberration was present. Subsequent calibration tests indicated that the spherical aberration was not internal to the WF/PC.

Corrections to the imaging defects due to misalignment were attempted by tilting and decentering the secondary mirror, but these adjustments did not improve the wavefront or the image quality. Further analysis and computer simulation of the WF/PC images indicated that 0.5-wave rms wavefront spherical aberration at 547 nm (equivalent to 0.43-wave rms wavefront error at 632.8 nm) existed in the telescope (Figure 6-1). When interferograms taken by the WFS also indicated severe spherical aberration, the HST Project Manager was notified, and the Contingency Plan was put into effect.

At this point, the activity began centering on determining which mirror, or perhaps both mirrors, had the incorrect shape. Error in the primary mirror would exhibit spherical aberration both along the axis of symmetry, where the WF/PC is located, and off-axis, where the FGS, WFS, and Faint Object Camera are located. If the secondary mirror were flawed, there should have been a large amount of coma in addition to the spherical aberration. No significant amount of coma was detected and, consequently, it was decided that most of the error resided in the primary mirror.

The NASA Administrator directed the MSFC Project Office to establish an Independent Optical Review Panel to further investigate the problem and recommend follow-on actions. Shortly thereafter, the Hubble Space Telescope Optical Systems Board of Investigation was formed to determine the technical facts behind the failure.

## **B. SOURCES OF ERROR**

The HST investigation indicated some inconsistencies in the primary mirror's test data. The historical test data showed that the primary mirror appeared to have spherical aberration when tested against the refractive null corrector, which was used to test the vertex radius of the primary mirror. At the time of the fabrication, P-E believed (without independent verification) that some level of error may have existed in the RvNC. An analysis conducted by the Board verified that the RvNC was accurate to better than 0.02 wave rms.

The final test data for the primary mirror, obtained using the reflective null corrector, indicated that the mirror exceeded the specifications. The Board found interferograms relating to the RvNC test (found in Appendix D), which indicated a surface-figure error of about the right magnitude and sign to explain the errors existing in the operational telescope. Since a perfectly polished mirror would have shown no error on either null corrector, it was evident to the Board that an error actually existed in the RNC.

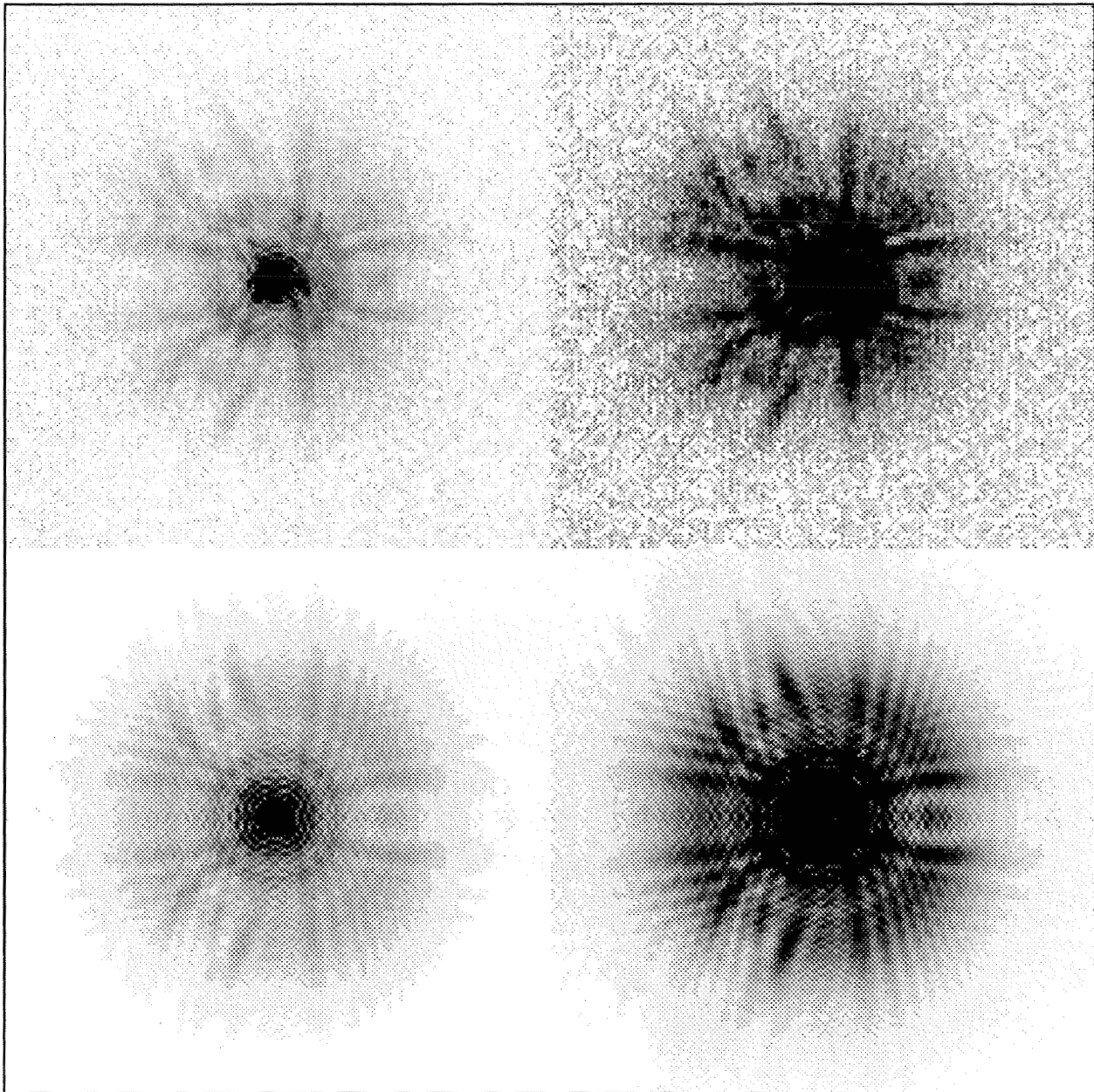

(a) Recorded image of the PC5 star taken on June 14, 1990, with a 0- $\mu\text{m}$  inside focus.

Figure 6-1. Planetary Camera images versus computer simulations. The images in the top frames were taken with the Planetary Camera; those in the bottom frames are computer simulations created using an optical model with 0.5-wave rms wavefront error at 547 nm.



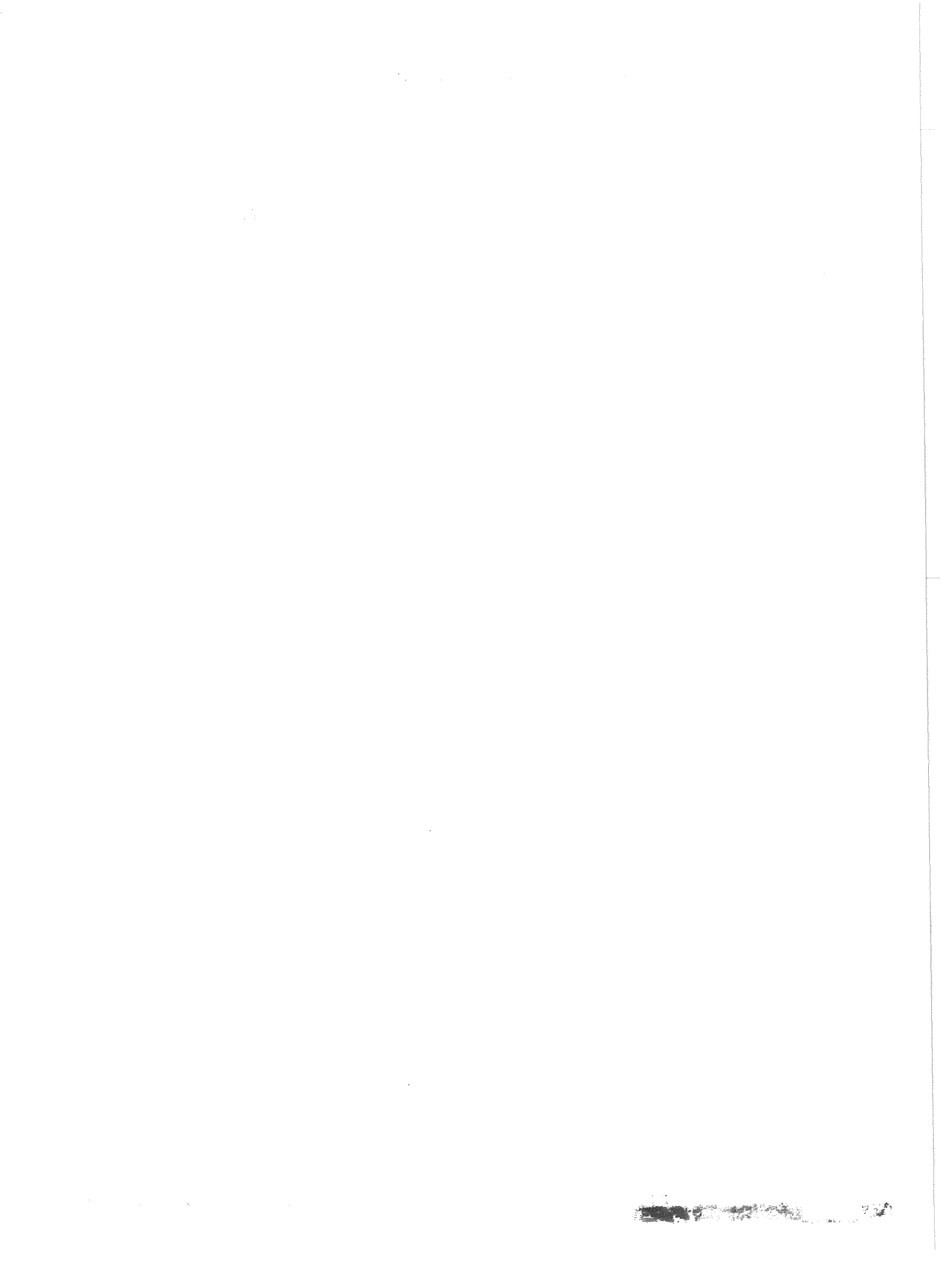

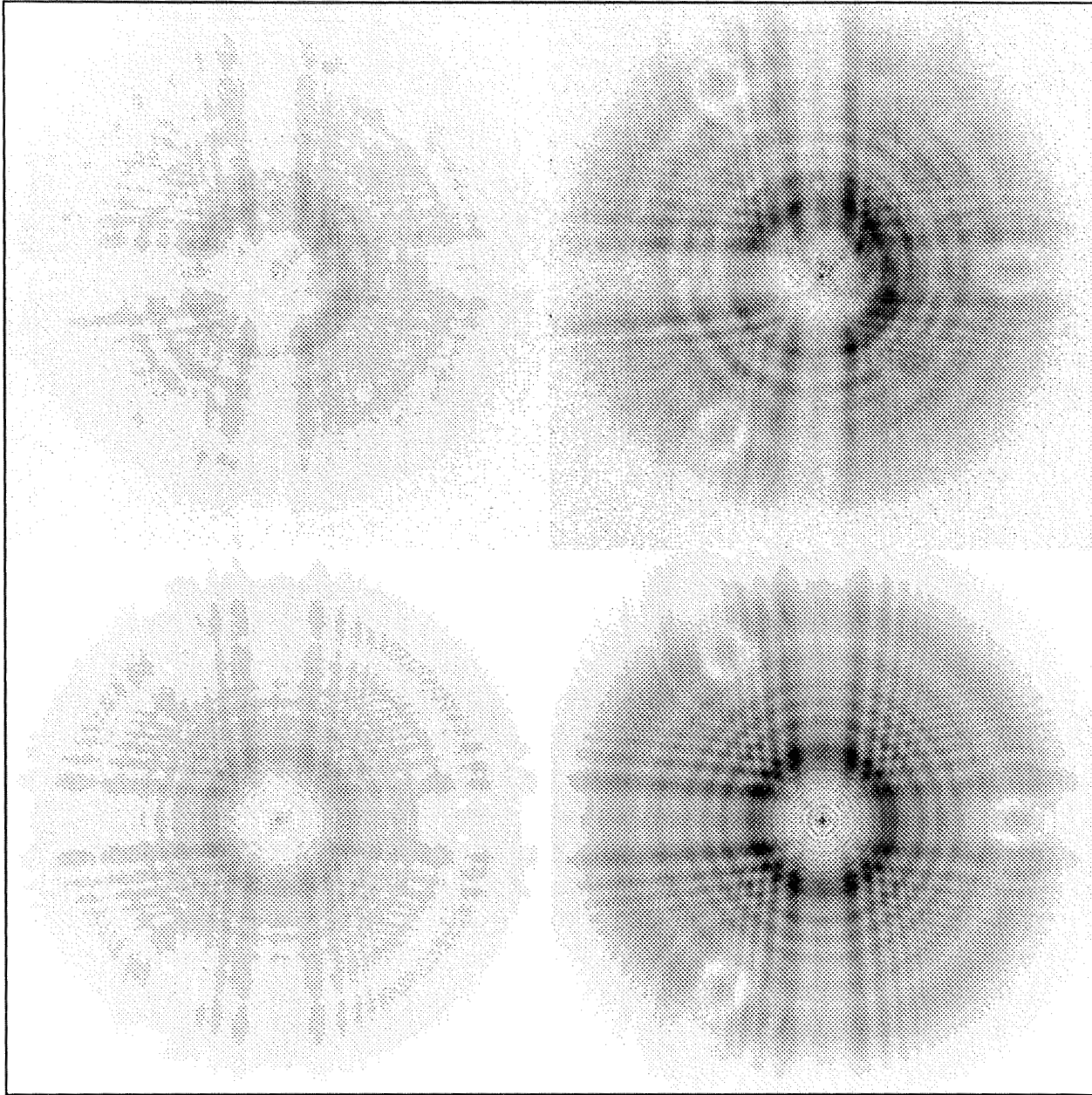

(b) Recorded image of the PC5 star taken on June 21, 1990, with a  $-300\text{-}\mu\text{m}$  inside focus.

Figure 6-1 (continued). The images in both (a) and (b) show a linear-intensity display on the left, and a logarithmic ("stretched") image display on the right. The focal position denotes the position of the secondary mirror. (Data were supplied by Dr. Jon Holtzman.)



A fault-tree analysis of the RNC and the manufacturing data indicated three reasonable possibilities for the error:

- (1) The field lens was inserted backward.
- (2) The index of refraction of the field lens was incorrect (i.e., the wrong glass was used).
- (3) The optical elements were incorrectly spaced (a circumstance that seemed highly unlikely because of the method used to set the lens spacings).

It was possible to be so specific because spherical aberration is a symmetric error and can only be produced by a longitudinal spacing error. A more extensive analysis to cover other, less viable causes of spherical aberration was halted once the Board agreed on the cause of the on-orbit spherical aberration.

The Board decided that no tests were to be performed on the null correctors that might in any way disturb their present condition, because the null correctors were the only direct links by which to determine the actual shape of the primary mirror in orbit. This precise shape data would be needed if the telescope were to be fixed or brought back to the originally specified image quality.

Under this restriction, the RNC could not be moved from its place at the top of the test tower, nor could it be adjusted or disassembled. By design, the RNC had access ports in its sides so that it was possible to get at the various optical elements in order to make the necessary measurements.

The first test performed on the RNC was to insert the INC and take an interferogram on July 22, 1990. This interferogram was analyzed and compared with a previous interferogram taken with the INC in place. (This latter interferogram was found in a notebook of a P-E employee and was dated June 22, 1982.) Comparison of these two interferograms (Figure 6-2) shows virtually identical results, clearly indicating the existence of spherical aberration. These INC interferograms are corroborated by the RvNC interferograms, which also show spherical aberration (as discussed in Appendix D, Figure D-2). The combination of these interferograms led the Board to conclude that the CORI/RNC assembly is now essentially in the same state of operation as it was at the time the final measurements were made on the primary mirror.

Unverifiable testimony raised the possibility of a waiver having been granted for an optical spacing error in the INC. During the current investigation, an error in the design calculations was discovered that produced a small amount of spherical aberration in the INC. An analysis of the "as-built" INC conducted for the investigation showed that the instrument had an accuracy to better than 0.14 wave.

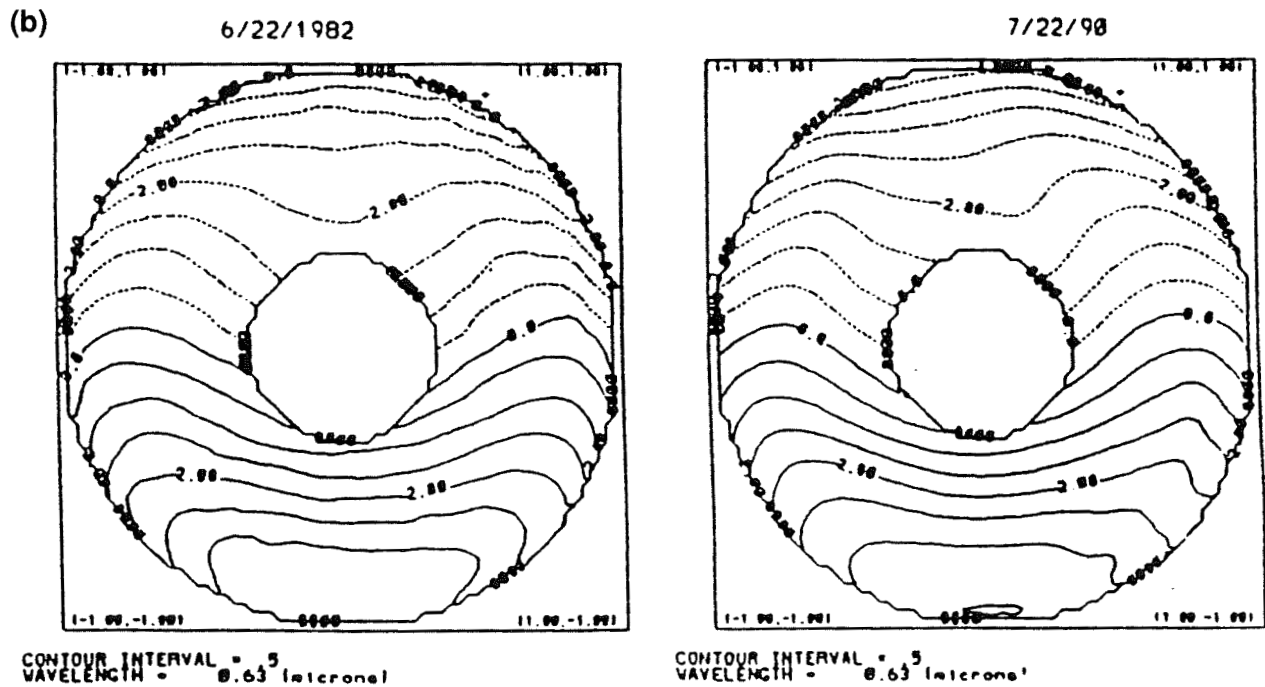
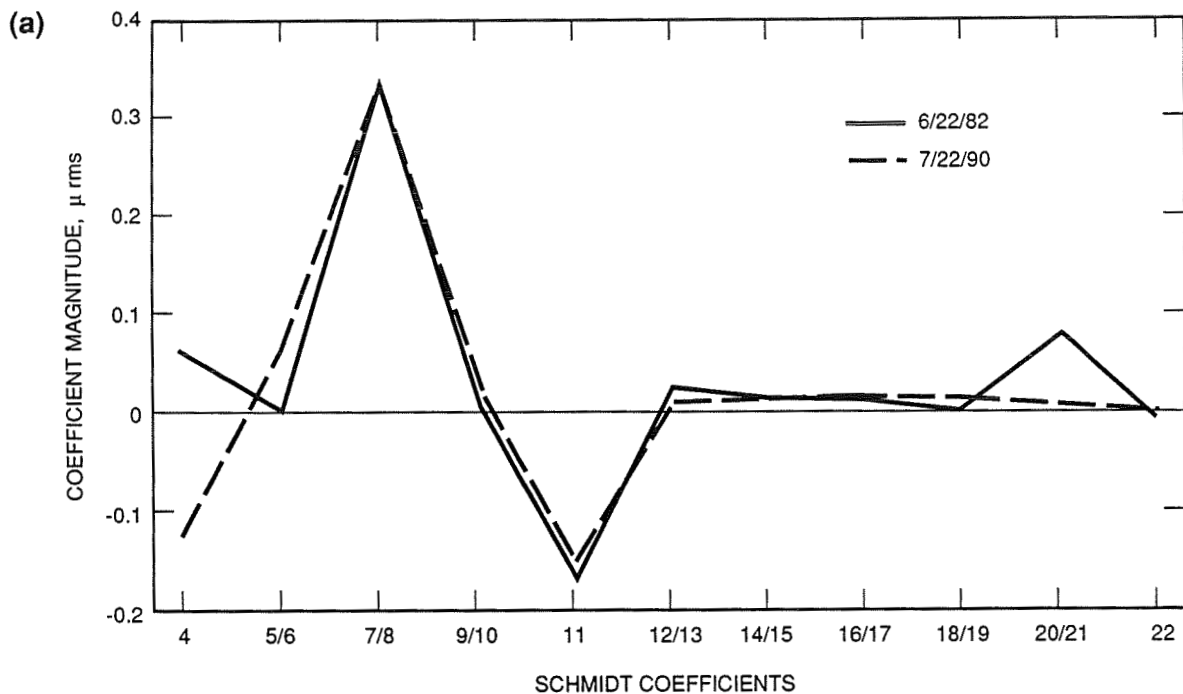

Figure 6-2. Comparison of 1982 and 1990 inverse null corrector data. (a) The coefficients which define the magnitude of various distortions to the wavefront were measured by the INC when it was inserted in front of the RNC in 1982 and in 1990. (b) The coefficient data were extracted from these plots of the interferograms.

The amount of spherical aberration introduced by the INC error is only a small amount compared to the amount of spherical aberration actually measured.

The first possibility of error in the RNC involved the field lens. Measurements were made and it was determined that the field lens was not put into the RNC assembly backwards.

The next test was to measure the effective focal length of the field lens to verify that the correct material had been used. The actual measurement determined the magnification of the field lens and verified that the correct glass had been used. Two spare lenses from the same lot were also measured for figure and focal length, and the measurements confirmed the results on the installed field lens.

Since the index was not in error, plans were made to measure the spacing of the field lens to the lower mirror in the RNC. This measurement could not be made as it was originally, because the metering rod used at the time of initial assembly was too long to fit in the assembled RNC and interferometer unit.

The RNC was designed such that high-precision (1- $\mu\text{m}$ ) measurements of the optical elements could be taken at any time. In the case of the 1.5-m prototype mirror, the metering rods could be positioned within the RNC to perform the spacing measurements. For the 2.4-m design, the spacing between the optics was greater and therefore the metering rods needed to be lengthened. The longest rod was lengthened in such a way that it could only be inserted in one piece and, consequently, a reverification of this spacing could not be made with this rod since disassembly of the RNC would be required. In principle, a new rod could have been designed in two pieces that would have allowed a remeasurement of the distance from the field lens to the center of curvature of the lower mirror.

The optical element spacing was measured in 1990 by shining collimated light up through the field lens using a Zygo interferometer as the source, and by placing a flat mirror at the focus of the field lens (a distance of about 0.55 m above the lens). The correct position of the mirror was determined by using the interferometer to find the best focus (Figure 6-3). The distance from the flat mirror was then measured down to the vertex of the lower mirror using a fixture in the mirror hole for a reference. This measurement showed that the field lens was about 1.3 mm too far from the lower mirror. Both the direction and the magnitude of the spacing error correctly explained the spherical aberration observed in the HST image data. The spacings of the other optical elements in the RNC were measured and were found to be correct.

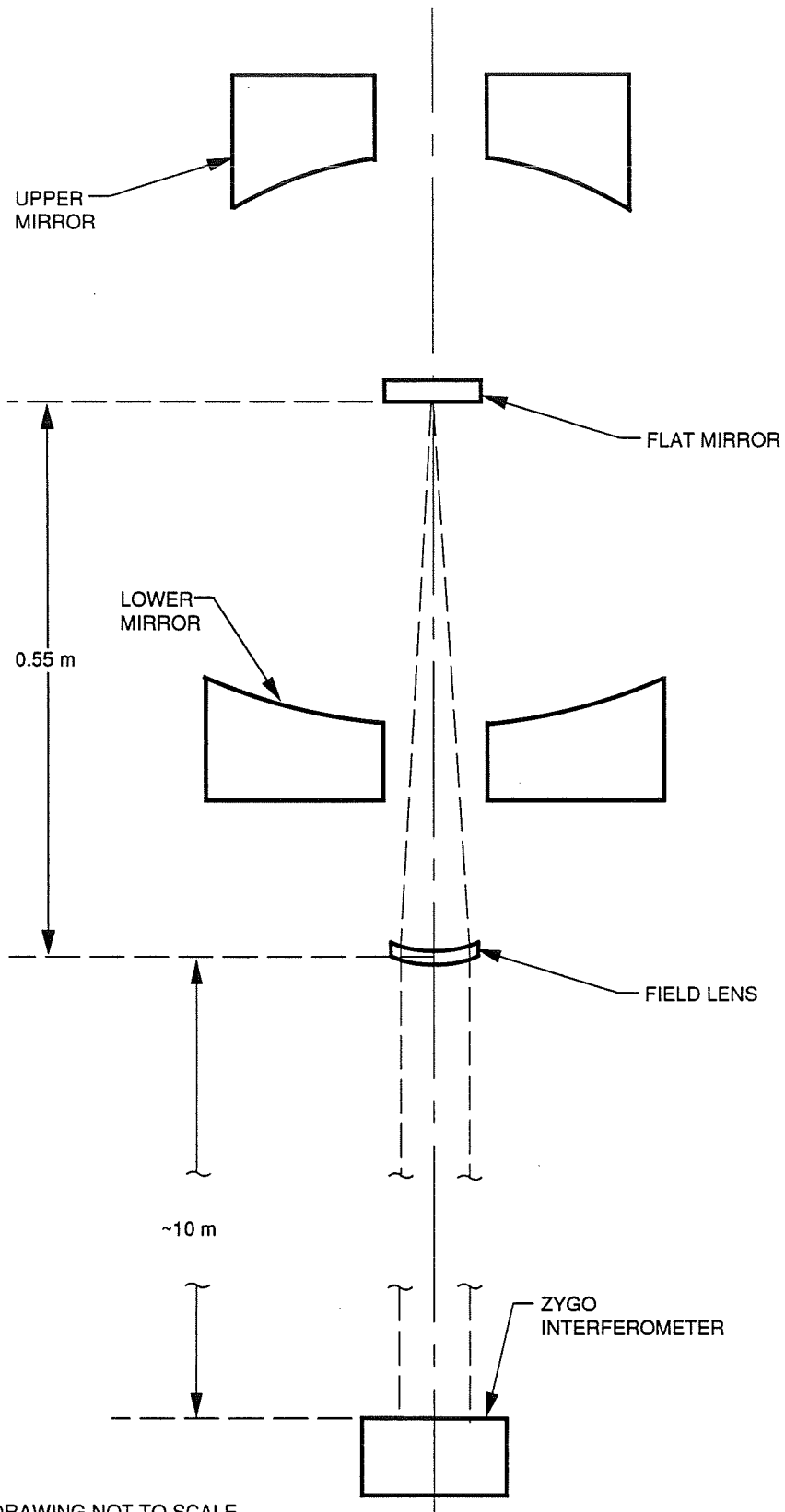

NOTE: THIS DRAWING NOT TO SCALE

**Figure 6-3. The 1990 spacing measurement between the field lens and the lower mirror of the reflective null corrector, using an optical test.**

In addition to the optical test used to detect the field-lens spacing error, a direct physical measurement was made from the field lens to the vertex of the lower mirror (Figure 6-4). A lightweight spacing rod and a new vertex plug were made. The results verified the previously measured spacing error to  $\pm 0.1$  mm. More accurate measurements of the displacement error will be done at a later time, as this information is necessary for an accurate determination of a prescription for the recovery optics.

When the field lens position error (FLPE) is taken into account and applied in correcting the data taken with the RNC, it results in a mirror shape that would account for most of the error observed in the HST images. Also, the interferograms taken with the RvNC were reprocessed and corrected for the as-built data available for the RvNC. This independent set of data yields a mirror shape very close in value to the RNC/FLPE data. These data led the Board to conclude that the predominant source of error had been found and was caused by the field lens position error. (See Appendix E for the HST performance based on the as-built data.)



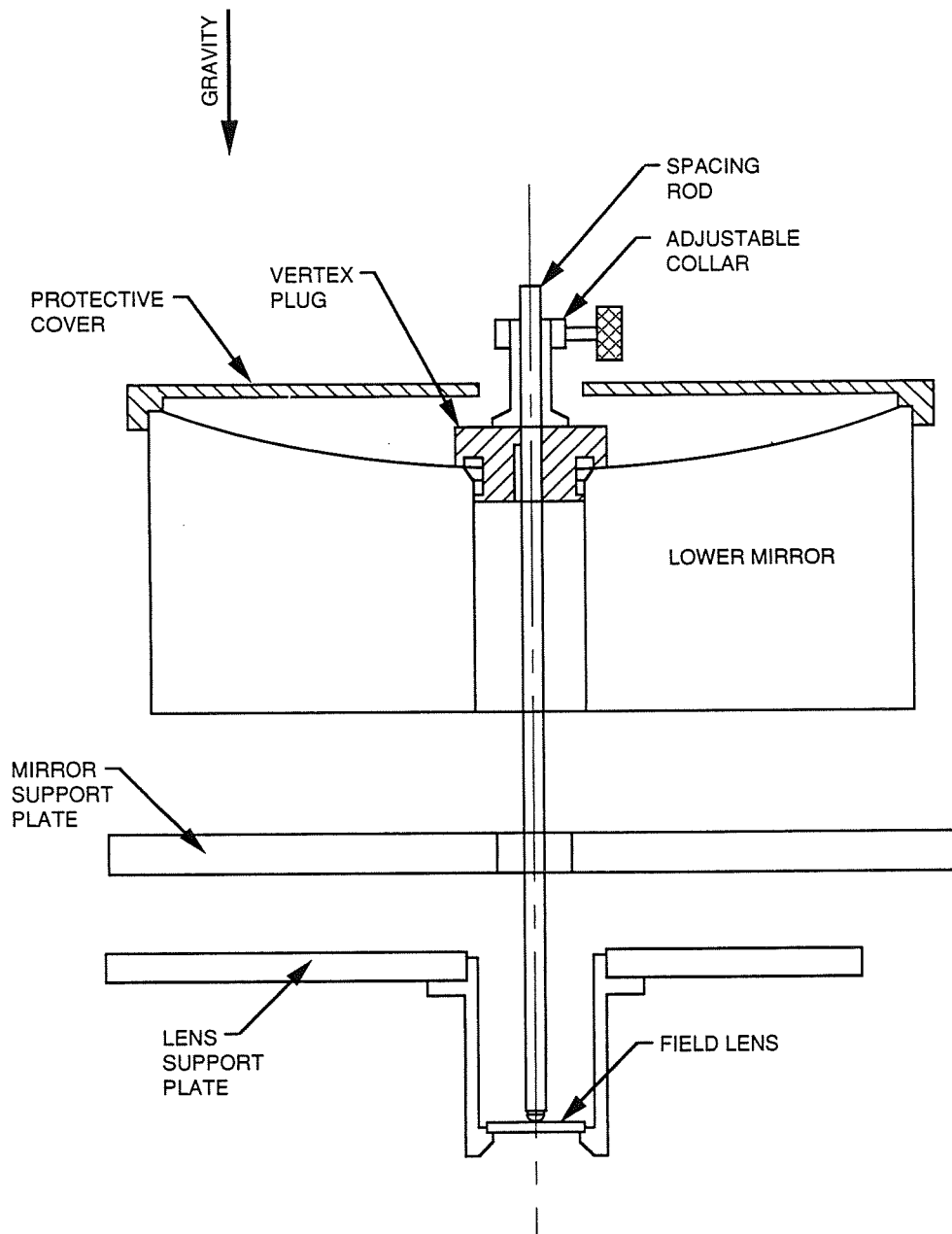

**Figure 6-4. The 1990 spacing measurement between the lower mirror vertex and the field lens of the reflective null corrector, using a mechanical technique.**

## **CHAPTER VII**

### **HOW THE ERROR OCCURRED**

#### **A. INTRODUCTION**

It has been established that the field lens was approximately 1.3 mm too far from the lower mirror of the RNC, which was used to figure the primary mirror. The RNC and its associated interferometer were found in the test chamber, unused and unchanged since the completion of the HST program. The RNC was measured in situ, and there is high confidence that the spacing error existed during the fabrication and test of the HST primary mirror. The cause of the spacing error, on the other hand, becomes a matter of conjecture, because the records necessary to reproduce what actually happened were not found. The scenario given below reproduces the events and provides a rationale of how the spacing error occurred. This scenario was simulated in the laboratory under the guidance of the Board and is the most likely cause of the error.

#### **B. METERING ROD MEASUREMENTS**

At the beginning of the program to build the 2.4-m Hubble primary mirror, P-E modified the RNC that had been used in building a 1.5-m mirror prototype. This modification required adding a new field lens and respacing the optical elements to create the correct shape for the larger mirror. Figure 7-1 is a schematic of this RNC, including the positions of the metering rods used to set the optics.

There were three metering rods (labeled A, B, and C) made of Invar, a metal with a small temperature expansion coefficient. The ends of the metering rods were rounded and polished because the very precise positioning of the optics in the RNC used an interferometer, rather than a mechanical measurement. This procedure involved auto-reflecting a focused beam of light off the end of a rod and observing an interference pattern from the beam that came back on itself. Centering the light beam on the rod end was essential for the measurement. To prevent the metering rod from being misaligned laterally with respect to the interferometer axis, P-E decided to attach "field caps" to one end of the rod (Figures 7-2 and 7-3). The field caps were fitted over the rod ends and had a small aperture in the center to ensure centering of the rod on the beam.

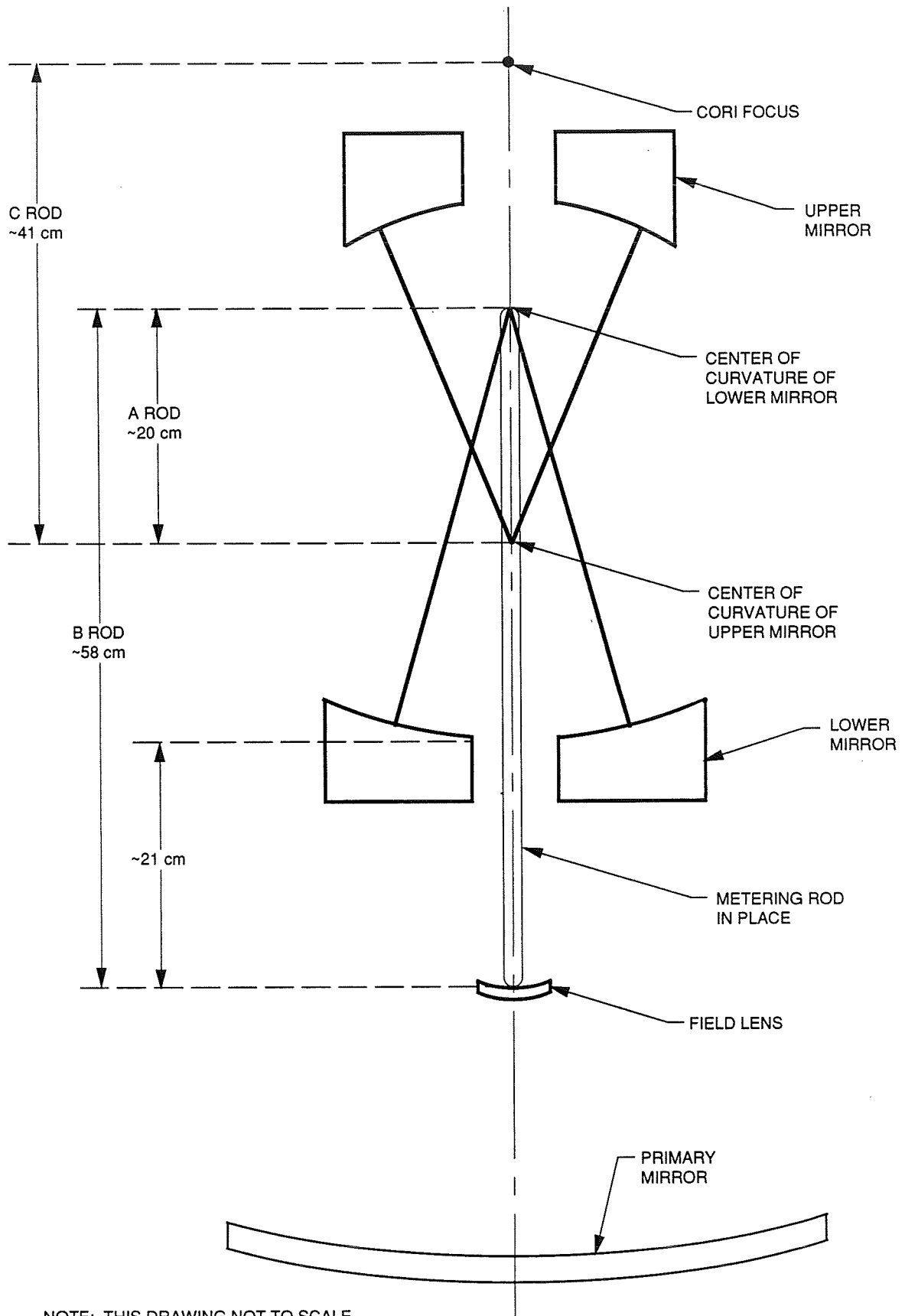

NOTE: THIS DRAWING NOT TO SCALE

**Figure 7-1. Position of metering rods used to space optical elements in the reflective null corrector.**

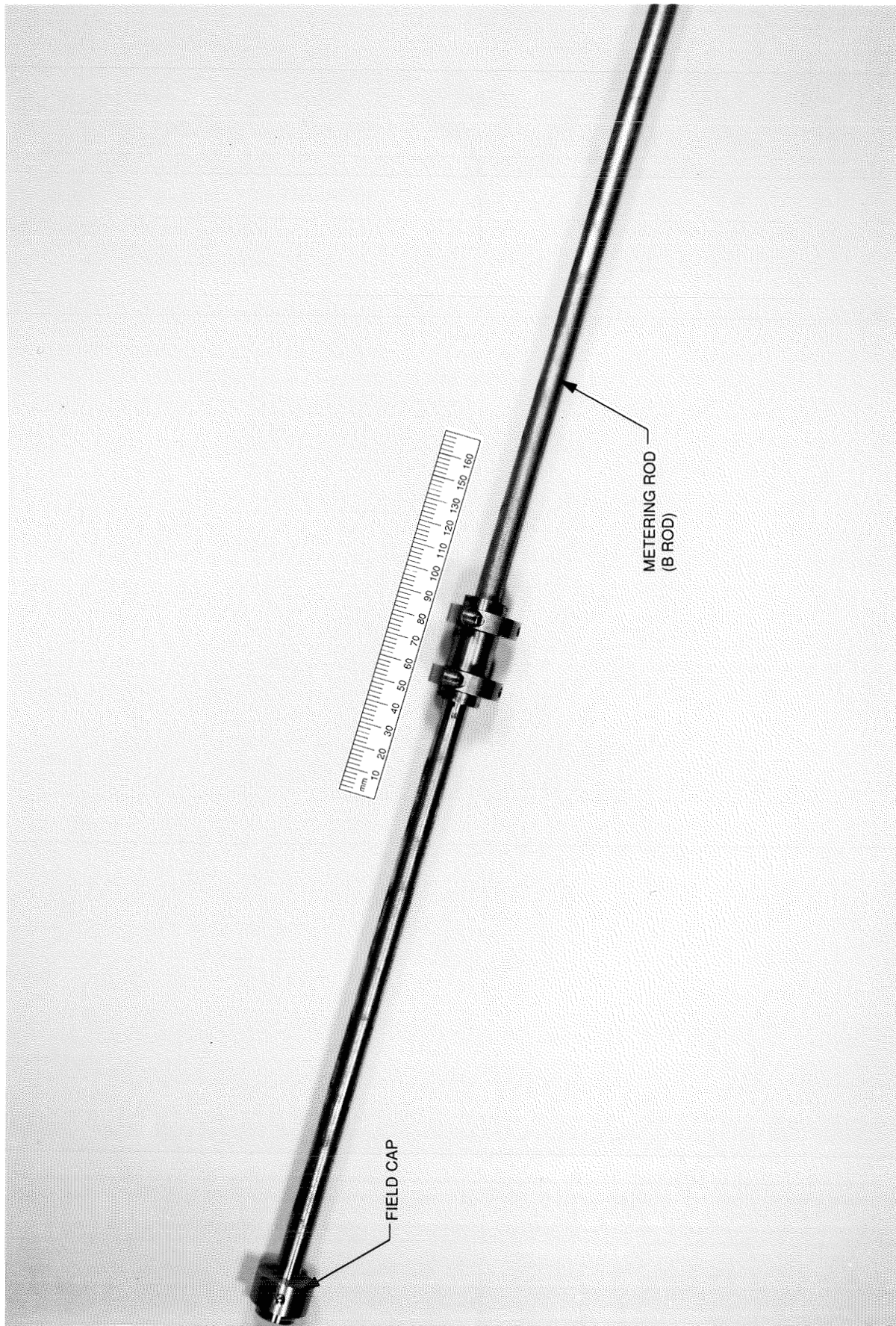

Figure 7-2. Metering rod (B rod) used to space the field lens and the center of curvature of the lower mirror in the reflective null corrector.



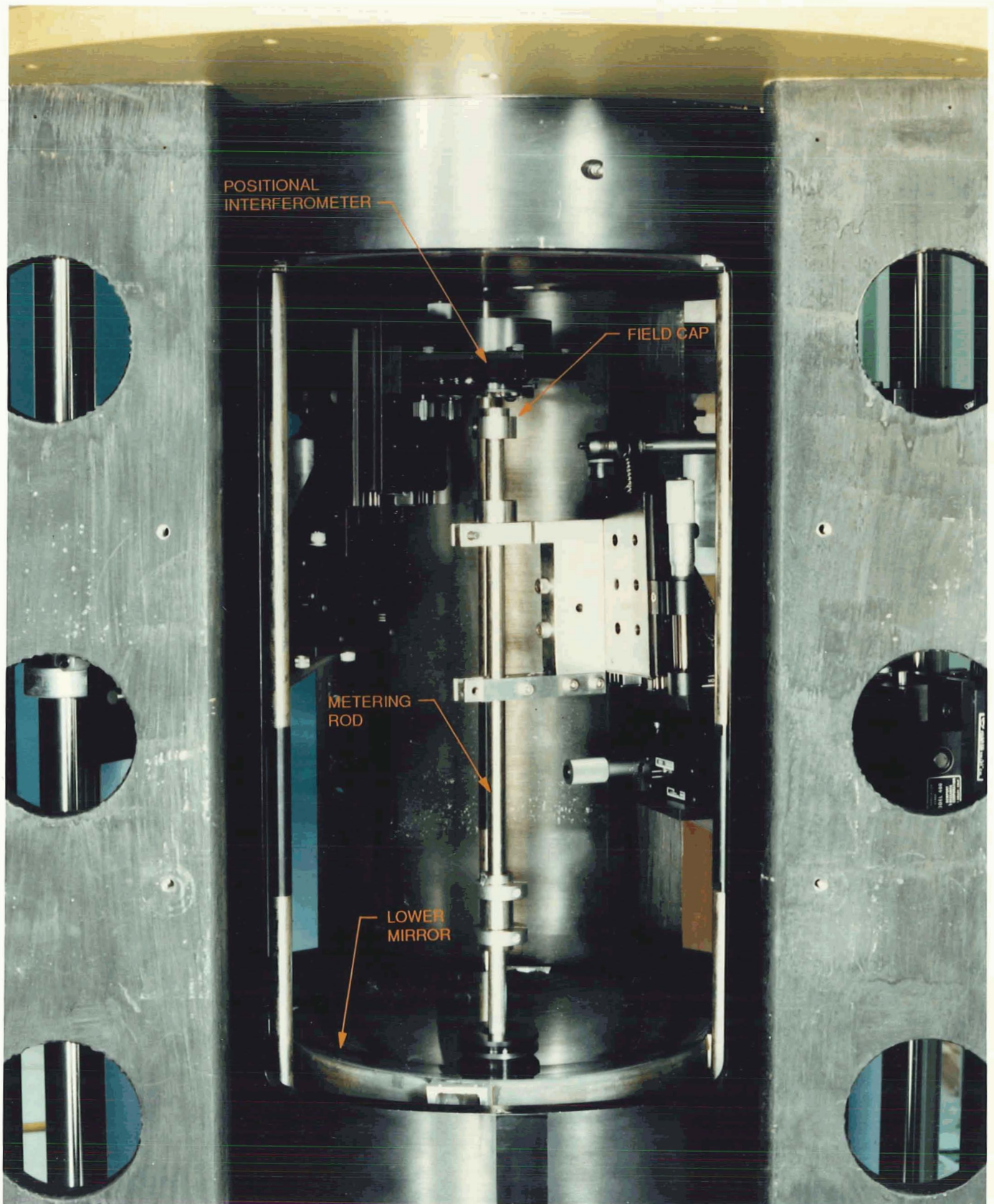

Figure 7-3. Metering rod in position between the field lens and the center of curvature of the lower mirror in the reflective null corrector.



The top surface of the field cap was covered with nonreflecting material; however, some of this material had, apparently inadvertently, broken away from a small area around the field cap aperture. It appears that the operator obtained reflection from the field cap where the nonreflecting material was absent, rather than the rod end, causing the 1.3-mm misspacing. A test performed in 1990 with the equipment showed that it was quite easy, even probable, to make this error with the configuration used. Figure 7-4 indicates how the displacement error occurred by reflecting light off the field cap, rather than the rod end, as designed. Figure 7-5 is a photograph of the field cap and shows the specular region around the aperture. (In this photograph, the broken-away coating appears darker than the surrounding region.)

With one end of the metering rod presumably located at the center of curvature of the lower RNC mirror, the field lens was then brought up to the end of rod B, but there was no adjustment left in the screws used for this positioning. More adjustment room was made by inserting spacers between the field lens and the lower mirror mounting plate. The adjustment mechanism was found not to be staked. Staking, i.e., securing the mechanism to prevent inadvertent movement, was a specified procedure. The final location of the field lens was then set with the addition of the spacers. As a result, the field lens was about 1.3 mm too far from its correct position relative to the lower mirror.



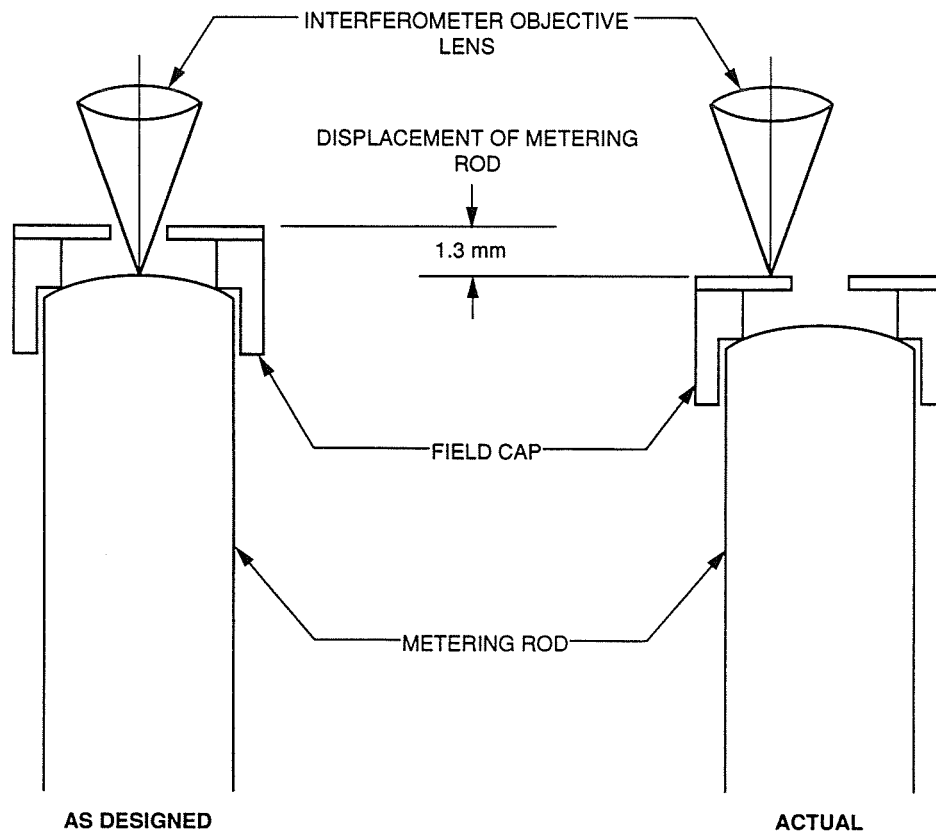

**Figure 7-4. Displacement due to the interferometer focusing on the field cap instead of the metering rod.**

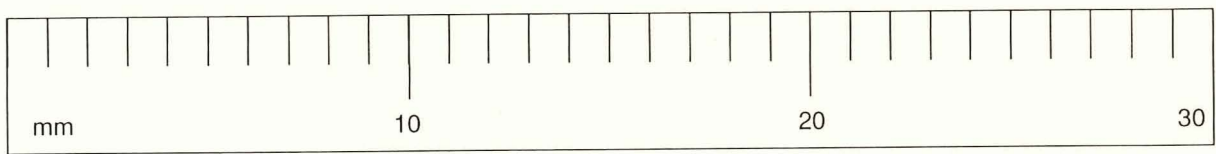
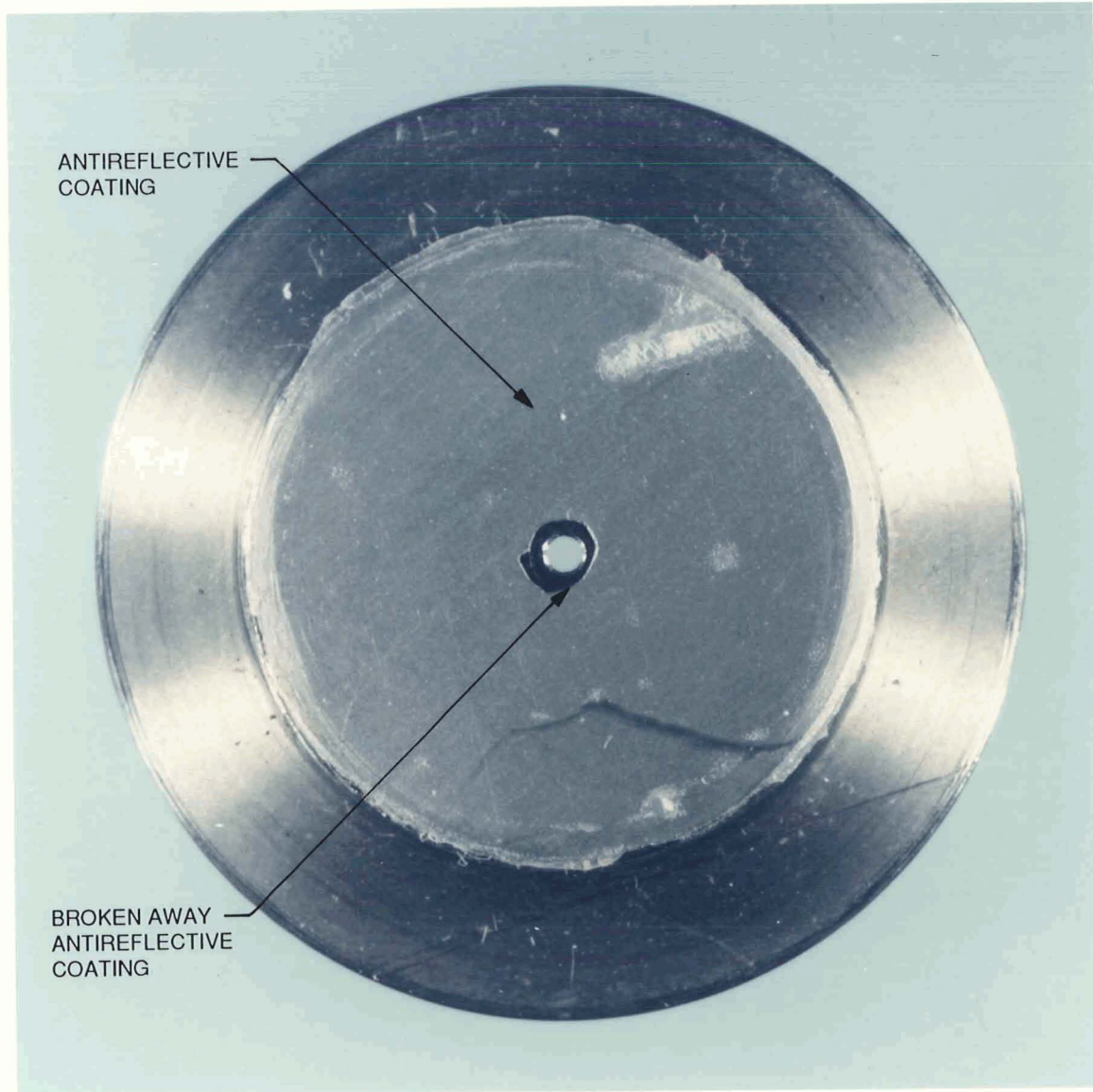

**Figure 7-5. Top view of the field cap, showing the aperture and the area where the antireflective coating had broken away.**

ORIGINAL PAGE  
COLOR PHOTOGRAPH

## CHAPTER VIII

### QUALITY ASSURANCE OBSERVATIONS

The error in the HST has brought the role of quality assurance (QA) into question, since the problem remained undiscovered before launch. From an examination of the evidence, it is clear that there were specific QA requirements in the contract for the building of the OTA and that an "OTA Product Assurance Plan" was written and released in 1978 by Perkin-Elmer. Less clear are the contract's data retention requirements and to which aspects of the P-E hardware they applied. While the OTA Product Assurance Plan did not specifically refer to testing of the RNC, the plan did set forth detailed requirements in regard to validation and engineering sign-off that would have ensured that the RNC would be adequately designed and tested. If this QA plan had been rigorously applied, it is probable that the HST error would never have occurred. At the very least, it would have been much easier to reconstruct what had happened if a complete record of the fabrication of the test equipment and mirrors had been retained.

Review of the existing documentation indicates that the QA function relating to the metrology of the primary mirror was inadequately staffed. Defense Contract Administration Services (DCAS), now Defense Contract Management Command (DCMC), personnel were not added to the Project's staff until after the primary mirror was completed. Both the MSFC and the P-E QA personnel were excluded from key areas and at critical times. This decision was made by P-E engineering management with the concurrence of the MSFC Project Office. The result of this decision was that an informed and independent evaluation of the assembly and manufacturing area was not done.

In addition, the P-E QA personnel reported to the OTA Project Manager rather than to someone independent of immediate Project pressures. This may also explain why QA personnel were apparently denied access to metrology areas where they could have hindered the data-taking and analysis process.

At the time of the primary mirror's polishing and testing, the quality reviews and audits conducted according to the QA Plan did not raise technical issues about the shortcomings of the test procedures prior to their implementation. The procedures did not provide criteria for the correct results of testing and thus did not provide guidance toward identifying unexpected out-of-limits behavior of the optical tests. In most cases, the expected results of the optical tests were not specified, and inexperienced personnel were not able to distinguish the presence of an unacceptable behavior of the tests. There was also no criterion given for the required experience of the observer approving passage of a milestone on the basis

of test results. In hindsight, and with the knowledge there was a problem with the mirror, it is easy to see that various technical issues about the test procedures, such as the lack both of independent tests and of any correlation of the results of related tests, should have been questioned.

When the primary mirror was transferred from P-E Wilton to P-E Danbury at the beginning of Phase II of the contract, a DoD-classified project was ongoing at the Danbury site. Initially, DoD imposed a restriction on the number of NASA personnel who had access to the Danbury facility. However, this restriction was seen by the MSFC Project Manager as being too constraining and then was subsequently renegotiated with DoD. Unlimited access by NASA personnel was allowed after that time. The DoD project did not prohibit NASA QA from adequately monitoring the P-E activity.

The Optical Operations Division of P-E imposed its own access limitations to the Danbury metrology area where the RNC and INC were assembled. This area was secured by a cipher lock door, and only metrology engineers from the Wilton facility were allowed access. QA personnel from both NASA and P-E were not informed that this test equipment was being assembled and were aware of its existence only after the RNC assembly was moved to the OTA test chamber. No formal manufacturing-process paperwork on this activity was filed; consequently, the QA organization did not become involved.

Other evidence that QA did not play as full a role as outlined in the QA Plan is shown by the lack of, or even callouts for, QA signatures on several procedures relating to the primary mirror metrology. Similarly, it is perhaps because the P-E QA personnel reported through the Project management that there is no written evidence that QA ever protested being denied access either to the primary mirror test area during the actual testing or to the area where the data were being analyzed.

Finally, there is no evidence of QA records calling into question the discrepancies in the actual test data that seem so obvious in hindsight. No mention has been found in any records that the RNC could not be recalibrated in the same manner as when it was first assembled, or that the RNC/INC test showed spherical aberration when it should not have. Neither was any mention made that the vertex radius test with the RvNC showed spherical aberration in the finished primary mirror when it should have shown none. There was no formal and centralized information management system to retain and categorize the voluminous data that defined the HST.

The documentation describing the addition of the spacers under the field lens to achieve the apparent proper spacing of this element was never filed or has

been lost in the intervening 10 years. This can be understood in part since the QA organization was not involved in this activity. A reference was made during the testimony that a Material Review Board was held on the spacer issue, but no documentation was found.

What is clear from the error that occurred, and the evidence found, is that QA has a significant role to play in the avoidance of similar problems on future programs. For this to happen, however, the role of QA must be understood and seen as a positive factor by top management. QA organizations must be adequately staffed by fully qualified individuals, and these people must be given free access to all aspects of the project, from conceptualization through final delivery. They should have clear authority to stop work on projects where there are unresolved quality issues. They should also have an independent reporting path to top management to avoid the undue influences and schedule pressures being imposed by the program or the engineering organizations.

Further, thorough and well-cataloged documentation of all these aspects of the project must be maintained by the contractor and/or NASA for the duration of the mission. To do otherwise will make recovery of salvageable missions improbable or impossible.

Additional quality assurance information on the HST can be found in an extensive report, *SRM&QA Observations and Lessons Learned*, by George A. Rodney, Associate Administrator, Office of Safety and Mission Quality, National Aeronautics and Space Administration, dated October 1990.

## CHAPTER IX

### WHY THE ERROR WAS NOT DETECTED PRIOR TO FLIGHT

The explanations for why the HST error was not detected before launch can be separated into two categories: factual and judgmental. Based on the test plan that was in place at the time of the fabrication of the HST mirrors, the factual issues presented in this Chapter were events that should have warned the Project personnel of the existence of a problem. The judgmental issues that follow are conclusions based on the Board's own expertise.

#### A. FACTUAL STATEMENTS

1. Complete reliance was placed on the reflective null corrector (RNC) to determine the shape of the primary mirror. It was determined that the RNC would be certified only by accurate measurement of the elements and the spacings. Although test philosophy placed great emphasis on "certification" of the RNC, the Board could not find documentation that the RNC was certified. In spite of the total reliance on the RNC, no independent measurements were made of the optical-element spacings of the RNC to verify the values. Although the RNC was designed so that spacings could be rechecked without disassembly, the actual implementation did not permit such measurements, and no remeasurement of spacings was made after initial assembly.

2. The erroneous measurement of the spacing of the field lens of the RNC led to the need to install spacers to increase the separation of the field lens from the lower mirror. The bolts securing the field-lens basket were not staked, suggesting a lack of quality surveillance, since securing bolts was a common and easily observable inspection to conduct. These anomalies should have led to a Material Review Board (MRB) approval document and a thorough consideration of the cause. Although the NASA representative recalls approving such an MRB, no documentation was found.

3. After the RNC was assembled in the laboratory, an INC was set up below the RNC. The INC was intended to simulate a perfect mirror below the RNC so that any errors in the null corrector could be detected. The interferograms taken when using the INC to align the RNC/CORI indicated a spherical aberration pattern (see Figure D-3). The full RNC/CORI assembly was then moved to the top of the optical telescope assembly test chamber, and each time the primary mirror was tested the INC was used to check the alignment of the setup. As before, the same spherical aberration distortion was evident in the fringes. These aberration fringes

could not be aligned out and were incorrectly attributed to the spacing errors in the lens system of the INC. Perkin-Elmer's Optical Operation Division believed that the INC was not reliable when, in fact, it was quite accurate enough to detect the gross error, and indeed did so.

4. The vertex radius measurement taken by the refractive null corrector (RvNC) indicated the presence of spherical aberration (see Figure D-2). This information was dismissed, as it was in the case for the INC, because the RvNC was believed to be less precise than the RNC and therefore not reliable. It has been determined that the RvNC was easily accurate enough to detect the spherical aberration that existed, and its reliability should not have been discounted.

5. There were two other occasions when a careful analysis of the data might have revealed the problem:

- a. The primary mirror was ground and polished to an approximate shape, about 1 wavelength rms, using the RvNC for the test. This took place at Perkin-Elmer's facility in Wilton, Connecticut. The mirror was then transferred to P-E's Danbury facility, where the RNC was the test instrument for final polishing. At the time of transfer, the interferograms obtained with the RvNC were compared with those obtained from the RNC, and the discrepancy could have been noted. However, the data and the circumstances of transfer are unclear, and the requirements for transfer appeared to be adequately met; therefore no concern was noted.
- b. After the assembly of the OTA, tests were performed to assure proper focus position. Those tests were made with a 0.36-m telescope (subaperture test), and careful analysis of the data might have revealed the problem. However, the data were complicated by gravity sag because the OTA was mounted horizontally, and only the focus position was verified.

6. A range of feasible tests to verify the shape of the primary mirror were considered, but not carried out. Finally, no end-to-end tests were planned or implemented to verify the performance of the OTA.

## **B. JUDGMENTAL STATEMENTS**

The following judgements are offered with the recognition that there were many distractions and crises during this period—cost, schedule, threat of cancellation, mirror contamination, possibility of mirror distortion caused by

mount, etc. Nevertheless, the flaw occurred and, as can now be seen, these are factors that bear on that occurrence.

1. The proposal of P-E, accepted by NASA, to rely entirely on the RNC should have alerted knowledgeable people in P-E and NASA that special attention was required to certify the RNC; to the need for independent validation of the RNC and/or the primary mirror; and to the need to examine and review the test data for any indications of inconsistency. A project test plan that considered the various measurements, the possibilities of error in each, and the feasibility of independent checks should have been prepared by the implementing organization and externally reviewed.

2. The conclusion by P-E, accepted by NASA, that the RNC was the only device that would yield an accuracy of 0.01 wave rms at 632.8 nm led P-E to fail to consider any independent measurement which would yield less accuracy. In fact, such independent data were obtained incidental to other measurements and were rationalized away due to this mindset.

3. The HST development program was complex and challenging and there were many issues demanding management attention; the primary mirror was only one of these. Although the telescope was recognized as a particular challenge, with a primary mirror requiring unprecedented performance, there was a surprising lack of participation by optical experts with experience in the manufacture of large telescopes during the fabrication phase. The NASA Project management did not have the necessary expertise to critically monitor the optical activities of the program and to probe deeply enough into the adequacy and competence of the review process that was established to guard against technical errors. The record of reviews reveals no sensitivity to in-process data and no questioning of the test method.

4. The NASA Scientific Advisory Group did not have the depth of experience and skill to critically monitor the fabrication and test results of a large aspheric mirror. However, this Group should have recognized the criticality of the figure of the primary mirror and the fragility of the metrology approach, and these concerns should have impelled them to penetrate the process and ask for validation.

5. A highly competitive environment existed between Perkin-Elmer and the Eastman Kodak subcontractor. Although the manufacturing process and the method of measurement for the backup primary mirror were reviewed and approved by P-E, there was limited additional technical exchange of experience. NASA did not utilize the opportunity offered by this directed subcontract to validate, and gain confidence in, the P-E approach to the primary mirror manufacture.



6. Perkin-Elmer line management did not review or supervise their Optical Operations Division adequately. In fact, the management structure provided a strong block against communication between the people actually doing the job and higher level experts both within and outside of P-E.

7. The P-E Technical Advisory Group did not probe at all deeply into the optical manufacturing processes and, although they recognized the fragility of the measuring approach, they did not adequately assert their concerns or follow up with data reviews. This is particularly surprising since the members were aware of the history of manufacture of other Ritchey-Chretien telescopes, where spherical aberration was known to be a common problem.

8. The most capable optical scientists at P-E were involved closely with the production of the 1.5-m demonstration mirror and the design of the HST mirror and the test apparatus. However, fabrication of the HST mirror was the responsibility of the Optical Operations Division of P-E, which did not include optical design scientists and which did not use the skills external to the Division which were available at Perkin-Elmer.

9. The Optical Operations Division at P-E operated in a "closed-door" environment which permitted discrepant data to be discounted without review. During the testimony, it was indicated that some technical personnel in the Optical Operations Division were deeply concerned at the time that the discrepant optical data might indicate a flaw. There are no indications that these concerns were formally expressed outside this Division.

10. The quality assurance people at P-E, NASA, and DCAS (Defense Contract Administration Services, now Defense Contract Management Command) were not optical experts and, therefore, were not able to distinguish the presence of inconsistent data results from the optical tests. The DCAS people concentrated mainly on safety issues.

11. The basic product assurance requirements and formal review processes were procedurally adequate to raise critical issues in most safety, material, and handling matters, but not in optical matters.

12. The inability of P-E to provide the Board with vital archival data on the design and manufacture of the primary mirror is an indication of inadequate documentation practices, which hampered the Board in determining the source of the primary mirror error.

## **CHAPTER X**

### **LESSONS LEARNED**

#### **A. IDENTIFY AND MITIGATE RISK**

The Project Manager must make a deliberate effort to identify those aspects of the project where there is a risk of error with serious consequences for the mission. Upon recognizing the risks the manager must consider those actions which mitigate that risk.

In this case, the primary mirror fabrication task was identified as particularly challenging due to the stringent performance requirements. The contractor clearly specified in the proposal that total reliance would be placed on a single test instrument and that no optical performance tests would be made at higher levels of assembly. Therefore, OTA performance would be determined by component tests and great care in precision assembly. Although NASA accepted this proposal, the methodology should have alerted NASA management to the fragility of the process, the possibility of gross error (that is, a mistake in the process), and the need for continued care and consideration of independent tests.

The history of spherical aberration in the primary mirrors of Ritchey-Chretien telescopes was known to some of the optical scientists involved, but did not lead to specific recommendations early in the Project. Late in the Project an advisory group did call out the risk of gross error and suggested simple tests to check for such errors. This recommendation was not seriously considered, primarily due to total lack of concern that such a risk was reasonable, but also in view of cost and schedule problems.

Several methods of detecting the flaw were inherent in the testing, but Project management did not recognize the value of or need for independent tests. Project management was concerned about the performance specifications and directed a subcontract to Eastman Kodak Company for an alternate primary mirror. The Eastman Kodak mirror was fabricated and tested using quite different techniques. The mirror or the instrumentation could also have served as cross-checks for gross error. Such error checks were not made, again due to total lack of concern about the possibility of gross error. Project management failed to identify a significant risk and therefore failed to consider mitigating actions. A formal discipline such as fault-tree analysis might have assisted the manager in directing his attention to this risk.

## **B. MAINTAIN GOOD COMMUNICATION WITHIN THE PROJECT**

While proper delegation of responsibility and authority is important, this delegation must not restrict communication such that problems are not subject to review. In this case, the Optical Operations Division of P-E was allowed to operate in an artisan, closed-door mode. The impermeability of this Division seems astounding. The optical designers at P-E did not learn how their designs were being implemented; e.g., if the designer of the null correctors had been following their use, the data from the INC and the RvNC likely would not have been discounted. The data indicating the flaw was of great concern to some members of the division. Testimony indicates that their concerns were addressed at the level of the head of metrology and the division manager, but were not discussed outside the division at all. There were individuals who were not satisfied by the decision to rely only on the RNC data and remained deeply concerned. Their concerns and the data which caused them did not seem to come to the attention of anyone external to the division. P-E management should have been sensitive and open to these concerns. The P-E Technical Advisory Group should have found out what was going on in the Division and insisted on reviewing in-process data. NASA Project management should have been aware that communications were failing with the Optical Operations Division.

Contributing to poor communications was an apparent philosophy at MSFC at the time to resolve issues at the lowest possible level and to consider problems that surfaced at reviews to be indications of bad management.

A culture must be developed in any project which encourages concerns to be expressed and which ensures that those concerns which deal with a potential risk to the mission cannot be disposed without appropriate review, a review which includes NASA project management.

## **C. UNDERSTAND ACCURACY OF CRITICAL MEASUREMENTS**

The project manager must understand the accuracy of critical measurements. P-E concluded, based on design considerations, that the RNC was the only test device which could achieve the required precision. They stated that its performance could not be determined by optical test but would be determined by component and assembly measurements which could be made in situ. P-E engineers regarded the RNC as "certified" and the INC and RvNC as "uncertified." The terms were not defined, and "certification" was not documented. P-E discounted evidence of spherical aberration from INC and RvNC measurements on the basis of "uncertified" status. In fact, the Board reviewed a recent as-built error analysis of both devices. The review showed the RvNC to be

accurate to 0.02 wave rms and the INC to 0.14 wave rms. This indicates that the INC is a factor of three more accurate than the error observed in the INC/RNC interferograms. While in-process data were not subject to external review, which is another lesson, the methodology of test instrument use was reviewed by P-E and NASA management. This review could and should have questioned the judgment not to use the INC or the RvNC as independent checks of the *accuracy* of the RNC even though the *precision* was not to specification. Project management must understand critical tests and measurement.

In addition, the project management must seriously consider the classification of test equipment that directly impacts the flight hardware. The RNC was classified as standard test equipment, which means that the RNC was not subject to the rigorous documentation and review requirements demanded of items classified as flight hardware equipment. Under the contract, there were no Government regulations requiring that records for the RNC be maintained. Considering the importance placed on the RNC in the test program, management should have upgraded the level of classification of this equipment.

Key decisions, test results, and changes in plans and procedures must be adequately documented. In preparing such documentation, individuals are forced to review and explain inconsistencies in the test data. This also provides a communication link to those individuals who are responsible for overseeing the project.

#### **D. ENSURE CLEAR ASSIGNMENT OF RESPONSIBILITY**

Project managers must ensure clear assignment of responsibility to QA and Engineering. NASA QA personnel were not optical system experts. The Project relied upon P-E Engineering to establish test and fabrication procedures, and P-E or NASA QA generally verified that Engineering approved and certified accomplishment of procedures. However, at times, NASA management seemed to rely on QA to verify the adequacy of procedures and the fact that they were satisfactorily accomplished. This lack of clarity apparently led to incomplete documentation and may have contributed to faulty procedures. The project manager must know what QA can and cannot do, and when it is necessary to rely on engineering for verifying its own procedures, management should be alert to the need for independent checks.

Quality assurance, to be truly effective, must have an independent reporting path to top management.

## **E. REMEMBER THE MISSION DURING CRISIS**

There will be a period of crisis in cost or schedule during most challenging projects. The project manager must be especially careful during such periods that the project does not become distracted and fail to give proper consideration to prudent action. At one point in the fabrication cycle of the primary mirror, an urgent recommendation for independent tests to check for gross error entered the system, but was apparently not acted upon. Again, at the completion of mirror polishing, the final review of data for a final report was abandoned and the team reassigned as a cost-cutting measure.

## **F. MAINTAIN RIGOROUS DOCUMENTATION**

The project manager should ensure that documentation covering design, development, fabrication, and testing is rigorously prepared, indexed, and maintained. Because quality, at a minimum, consists in meeting requirements, it is not possible to determine whether the necessary quality is being achieved if the requirements are not set forth in sufficient detail and maintained in retrievable archival form. Adequate documentation also helps maintain a disciplined approach to fabrication and testing processes, especially with so complicated a project as the HST.

## GLOSSARY

arcsec (arcsecond)	A wedge of angle, 1/3600th of one degree, in the 360-degree sphere that makes up the sky. An arcminute is 60 seconds; a degree is 60 minutes.
astigmatism	A defect of curvature that prevents sharp focusing and degrades the quality of an image.
axial	Along the optical axis of a telescope.
baffle	Structure that obstructs stray light from the incoming image (see Figure 2-1).
C&DH	command and data handling
Cassegrain	A type of two-mirror telescope that reflects or "folds" incoming light.
coma aberration	A type of aberration where the rays from a point source do not meet at one focus, but rather spread into a comet-shaped area (see Figure C-2).
concave	A mirror surface that bends outward to expand an image.
convex	A mirror surface that bends inward to concentrate an image.
CORI	Coaxial Reference Interferometer
DCAS	Defense Contract Administration Services, now DCMC
DCMC	Defense Contract Management Command, formerly DCAS
DoD	Department of Defense
Einstein Observatory	The High-Energy Astronomy Observatory (HEAO-2) managed by Marshall Space Flight Center.
EK	Eastman Kodak Company
FGS	fine guidance sensors
figure	The shape of an optical surface.
first light	When an instrument's shutter is first opened and light enters the instrument.

FLPE	field lens position error
FOC	Faint Object Camera
focal plane	The geometric plane where incoming light is focused by the telescope.
fringe pattern	The bright and dark alternating intensity pattern in an interferogram (see Figure D-1).
GSFC	Goddard Space Flight Center
HDOS	Hughes Danbury Optical Systems, Inc.
Hindle test	An arrangement for testing a convex hyperboloid by retroreflection; used to shape the Hubble Space Telescope's secondary mirror.
HST	Hubble Space Telescope
hyperboloidal	A slightly deeper curve, mathematically, than a parabola; the shape of the Hubble Space Telescope's primary mirror.
image plane	The geometric plane in the telescope where the image is reconstructed.
INC	inverse null corrector
interferogram	A photograph of an interfering light pattern; used to test the figures of the Hubble Space Telescope's mirrors.
JPL	Jet Propulsion Laboratory
knife-edge test	A simple, qualitative test to measure an optical figure.
LMSC	Lockheed Missiles and Space Company, Inc.
MRB	Material Review Board
MSFC	Marshall Space Flight Center
NASA	National Aeronautics and Space Administration

OOD	Optical Operations Division (at the Perkin-Elmer Corporation)
ORA	Optical Research Associates
OTA	Optical Telescope Assembly
PA	product assurance
PCS	pointing control system
P-E	Perkin-Elmer Corporation, now HDOS
QA	quality assurance
QC	quality control
radial	Perpendicular to the optical axis of a telescope; for example, instruments placed at a 90-degree angle from the optical axis of the Hubble Space Telescope.
R-C	Ritchey-Chretien—A type of Cassegrain telescope where both the primary and secondary mirrors are hyperboloidal to correct for image aberrations; the Hubble Space Telescope's Optical Telescope Assembly (see Figure 2-1).
rms	root mean square
RNC	reflective null corrector
RvNC	refractive null corrector
SAIC	Science Applications International Corporation
spectrum	The wavelength range of light in an image.
SRM&QA	safety, reliability, maintainability, and quality assurance
TDRSS	Tracking and Data Relay Satellite System
vertex radius test	A comparative measurement of the primary mirror's radius of curvature at its center.
wavefront	The surface composed of all the points just reached by a bundle of light rays from a source.



wavelength (wave)	The distance in a wave from any one point to the next point of corresponding phase (for example, the distance from one wave crest to the next is one wavelength).
WF/PC	Wide Field/Planetary Camera
WFS	wavefront sensors

**APPENDIX A**

**CHARTER AND MEMBERSHIP**

**OF THE BOARD**



National Aeronautics and  
Space Administration

Washington, D.C.  
20546

JUL 2 1990

SPS

Reply to A11101

TO: Director, Jet Propulsion Laboratory  
ATTN: Dr. Law Allen

FROM: S/Associate Administrator for Space Science and  
Applications

SUBJECT: Establishment of Hubble Space Telescope Optical  
Systems Board of Investigation

In accordance with the Hubble Space Telescope (HST) Contingency Plan dated 2/15/90, the Office of Space Science and Applications is establishing a "Hubble Space Telescope Optical Systems Board of Investigation." I am hereby appointing you to serve as the Chairman of that Board. It is our intent to establish a board whose members, primarily from outside NASA, are world renowned in the field of optical systems and spacecraft quality control. This Board of Investigation will be a working group charged to review, analyze, and evaluate the facts and circumstances regarding the manufacture, development and testing of the Optical Telescope Assembly.

Your charge as Board Chairman is to determine how and when the problems in the Optical Telescope Assembly (OTA) occurred, thereby leading to the observed spherical aberration, and how this aberration could go undetected prior to launch. The group will report the results of their evaluation to the Associate Administrator for Space Science and Applications. This group is not established to render, advise, or make recommendations.

This operational working group is an exception to the provisions of the Federal Advisory Committee Act. There is no requirement for public notice as to meetings or to have such meetings open to the public.

The immediate point of contact at NASA Headquarters for information, assistance and support will be the Director, Astrophysics Division, Dr. Charles Pellerin. He can be reached at 202/453-1437 (office) or 202/488-1423 residence).

Again, I want to convey my appreciation for your willingness to chair this board. Your leadership of this group will be instrumental in assuring a systematic review of the HST Optical Systems.



L. A. Fisk

CONCURRENCE:

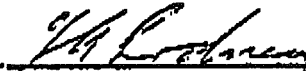

---

George Rodney  
Associate Administrator for  
Safety and Mission Quality

cc:

A/Adm Truly  
AD/Mr. Thompson  
G/Mr. Frankel  
S/Mr. Diaz  
    Mr. Alexander  
    Mr. Rhome  
    Ms. Schmoll  
SPS/Ms. Phillips  
SZ/Dr. Pellerin  
L/Mr. Kress  
P/Mr. Sheehan  
X/Mr. Pedersen  
Q/Mr. Rodney

ORIGINAL PAGE IS  
OF POOR QUALITY

## MEMBERS OF THE BOARD OF INVESTIGATION

*Dr. Lew Allen, Chairman*

Director, Jet Propulsion Laboratory  
Pasadena, California

*Dr. Roger Angel*

Professor of Astronomy, Steward Observatory  
University of Arizona  
Tucson, Arizona

*Mr. John D. Mangus*

Head, Optics Branch, Space Technology Division  
NASA/Goddard Space Flight Center  
Greenbelt, Maryland

*Mr. George A. Rodney*

Associate Administrator for Safety and Mission Quality, NASA Headquarters  
Washington, DC

*Professor Robert R. Shannon*

Director, Optical Sciences Center  
University of Arizona  
Tucson, Arizona

*Mr. Charles P. Spoelhof*

Vice President (Retired), Eastman Kodak Company  
Pittsford, New York

**APPENDIX B**

**SUMMARY OF PROCEEDINGS**

**HUBBLE SPACE TELESCOPE  
OPTICAL SYSTEMS BOARD OF INVESTIGATION**

## INTRODUCTION

The Hubble Space Telescope Optical Systems Board of Investigation was formed in early July 1990 at the request of Dr. Lennard Fisk, Associate Administrator for Space Science and Applications, NASA. Dr. Lew Allen, Director of the Jet Propulsion Laboratory, was appointed Chairman of the Board. The purpose of the Board was to review, analyze, and evaluate the facts and circumstances regarding the manufacture, development, and testing of the Hubble Space Telescope Optical Telescope Assembly (OTA). The Board was not open to the public or press. All of the relevant documents and hardware at the OTA manufacturer, Hughes Danbury Optical Systems, Inc. (HDOS) were impounded soon after discovery of the flaw, in preparation for the investigation.

The objective of the investigation was to identify, to the degree possible, the causes behind an apparent manufacturing flaw in one of the mirrors in the OTA, and to determine why the flaw, which impacts the focusing ability of the OTA, was not discovered prior to the launch of the spacecraft. Parallel efforts aimed at making a definite determination of the nature and location of the flaw through analysis of data retrieved from the orbiting HST were ongoing at the onset of this investigation.

Serving the Board in an advisory capacity were Ms. Sarah Keegan, NASA Public Affairs Officer, and Mr. Gary Tesch, NASA Deputy General Counsel. Serving as staff to Dr. Lew Allen were Drs. Macgregor Reid and James Breckinridge, and, at the fourth meeting, Dr. Katherine Dumas, of the Jet Propulsion Laboratory. The Technical Recorder was Mr. Christopher Thompson of Science Applications International Corporation (SAIC). Representing Dr. Fisk at the Board meetings was Dr. Charles Pellerin, Director of the Astrophysics Division in NASA's Office of Space Science and Applications. All of the non-NASA employees on and serving the Board were sworn in as Special Government Employees in order to bind them to Government regulations regarding conflicts of interest and disclosure of proprietary data.

A full list of participants in each Board meeting follows the summary of that meeting.

**FIRST MEETING: JULY 5-6, 1990**  
**VITRO CORPORATION**  
**WASHINGTON, DC**

**A. SUMMARY**

The first meeting of the Board took place July 5-6, 1990, in a conference room in the offices of the Vitro Corporation at 400 Virginia Avenue, S.W., in Washington, DC. Dr. Roger Angel was unable to attend this meeting.

Dr. Fisk convened the Board on the afternoon of July 5 with a word of thanks and a reminder of the importance of the task that lay ahead. He charged the Board with determining the technical cause of the spherical aberration in the HST OTA and the reason why the aberration was not discovered prior to flight. He suggested that the Board look primarily at technical issues, noting that the period during which the mirrors were manufactured and integrated was turbulent for the HST program, with schedule and budget issues leading to a major reorganization, but that this history should only be considered to the extent that the Board found that it had an impact on the specific technical issue at hand. Dr. Fisk stated that he wanted a definite answer, rather than a fast one, and that the Board should do whatever it had to in order to uncover the cause of the problem.

Dr. Fisk also noted that there was great interest in the HST problems both in Congress and in the press. He stated that NASA would not direct any Board member not to speak to the press, but reminded them that it would be inappropriate to comment on the findings of the investigation until it is complete. Dr. Fisk also stated that the Board members should not release any of the documentation of the Board themselves, since the documentation would be released through formal NASA channels.

The first meeting of the Board focused on presentations arranged by the HST Project Office at Marshall Space Flight Center (MSFC). These presentations, some of which were provided by HDOS HST Project personnel, were essentially background and tutorials on the manufacturing and testing of the mirrors for the HST OTA at HDOS (then the Perkin-Elmer Corporation), in Danbury and Wilton, Connecticut. Based on information gathered during these presentations, and on input the Board received from the HST Independent Optical Review Panel regarding the ongoing analysis of on-orbit HST data relevant to the aberration (included as Attachment 1), the Board formed an initial plan for the investigation. This plan included document analysis, hardware testing, and personnel interviews. The Board concluded the first meeting with an agreement regarding the release of



impounded materials for the purpose of beginning a supervised investigation of the HST documents and test equipment at HDOS.

## **B. PARTICIPANTS**

All members of the Board were present, with the exception of Dr. Roger Angel, who was unable to attend either day of the meeting. Also in attendance:

### **NASA Headquarters**

Mr. Douglas R. Broome  
Mr. T. Jens Feeley  
Dr. Lennard Fisk  
Ms. Sarah Keegan  
Dr. Charles Pellerin  
Ms. Angela Phillips  
Mr. Gary Tesch

### **NASA/MSFC**

Mr. Daniel Johnston  
Mr. Charles O. Jones  
Mr. Fred S. Wojtalik

### **Hughes Danbury Optical Systems**

Ms. Kathleen Beres  
Dr. Terence Facey  
Mr. William S. Raiford  
Mr. John D. Rehnberg  
Dr. John C. Rich

### **Staff to the Board**

Dr. James Breckinridge, Jet Propulsion Laboratory (JPL)  
Dr. Macgregor S. Reid, JPL  
Mr. Christopher J. Thompson, Science Applications International Corporation (SAIC) (Technical Recorder)

**SECOND MEETING: JULY 25-26, 1990  
HUGHES DANBURY OPTICAL SYSTEMS  
DANBURY, CONNECTICUT**

**A. SUMMARY**

The second meeting of the Board took place on July 25-26 at the offices of Hughes Danbury Optical Systems, Inc. in Danbury, Connecticut. The full Board was in attendance and now included, as an observer, Dr. Robin Laurance of the European Space Agency.

In the interim since the first meeting, a controlled easement of the impounding of documents and hardware at HDOS had taken place, as authorized by the Board. Under the supervision of NASA and the Defense Contract Management Command in Bridgeport, Connecticut, a review of HST documentation and test equipment at HDOS was also undertaken. Also since the first meeting, the Board appointed Mr. Robert E. Parks, an independent optics consultant, to serve as its full-time, on-site representative. Mr. Parks participated in data review and test planning at HDOS and was available to the Board as needed. The Board members were in regular communication with one another and with Mr. Parks during this time. Each received pertinent documents and plans for review via datafax as they became available.

The meeting comprised status reports on work plan elements, reports on specific studies requested by the Board, and interviews with key former and current HDOS HST Project employees. The employees interviewed are listed below. As requested by the Board, HDOS presented a plan for characterizing the special test equipment known as null correctors used in manufacturing the HST primary mirror. HDOS also presented a status report on sensitivity analyses being performed on the test regimes and equipment used in characterizing the primary and secondary mirrors. These analyses, when complete, would provide mathematically feasible sources of the magnitude of spherical aberration observed in the HST imagery. The Board also reviewed options for detailed testing of a backup secondary mirror manufactured at the same time and according to the same specifications as the secondary HST mirror now on orbit. Finally, at the request of the Board, the HDOS HST Chief Scientist made a presentation on a focus test, using a 0.36-m collimator, that was performed several times on the OTA before and after it was shipped to Lockheed Missiles and Space Company for integration.

The interviews of current and former HDOS HST Project personnel were done in two phases. The first phase, during which only the Board, its staff, and the interviewees were present, was a group interview on the manufacturing and testing of the primary and secondary mirrors. This phase centered on the two individuals primarily responsible for these activities, but all of the interviewees were able to amplify and offer information as they saw fit. There was substantial discussion of the design of the null correctors (a refractive null corrector that was used for checking the coarse figure of the primary mirror prior to polishing, and a reflective null corrector that was used for precise measurement of the figure of the mirror during and after polishing) and how the null corrector measurement data, known as interferograms, were analyzed. The second phase of interviews was conducted by the Board members alone, questioning each individual one at a time in closed session. The technician who used the reflective null corrector assembly on the primary mirror, still an HDOS employee, also met with the Board and explained the procedure in open session on the second day.

Also during the second meeting, the Board toured the HDOS integration and test area where the primary mirror was polished and analyzed. The Board was able to visually inspect the exterior of the reflective null corrector assembly in the test tower, where it has remained unused since the last testing of the primary mirror in 1982.

The second meeting concluded with agreement for HDOS to conduct supervised, noninvasive visual inspection of the primary mirror test equipment, for HDOS to continue with the test equipment sensitivity analysis, and for HDOS to further model the tests they proposed for characterizing the null correctors. The Board decided to postpone the authorizing tests of the backup secondary mirror.

## **B. PARTICIPANTS**

All members of the Board were present, including, as an observer, Dr. Robin Laurance of the European Space Agency. Also in attendance:

### **NASA Headquarters**

Ms. Sarah Keegan  
Dr. Charles Pellerin  
Mr. Gary Tesch

**NASA/MSFC**

Mr. Larry Hill (26th only)  
Mr. John Humphreys  
Mr. Daniel Johnston  
Mr. Joseph Randall  
Mr. Fred S. Wojtalik

**Defense Contract Management Command (Bridgeport)**

Lt. Col. Ken Bohannon, USAF (25th only)

**Hughes Danbury Optical Systems**

Mr. Robert A. Arnold\*  
Mr. David Burch  
Mr. David Chadwick  
Mr. John Cunniff  
Mr. R. Thomas Dubos\*  
Dr. Terence Facey  
Mr. William Freeman  
Ms. Laurie K. Furey  
Mr. Robert Harned  
Mr. Michael Kasseris\* (26th only)  
Mr. Frank Krausz  
Mr. Malcolm MacFarlane  
Mr. Joseph Magner\*  
Mr. David Olson  
Mr. John D. Rehnberg  
Dr. John C. Rich

**Hughes Danbury Optical Systems (former employees)**

Mr. Raul E. Casas\*  
Mr. Louis Montagnino\*  
Mr. Abe Offner\*  
Mr. Ronald (Bud) Rigby\*  
Mr. Charles Robbert\*  
Mr. Albert F. Slomba\*

## **Staff to the Board**

Dr. James Breckinridge, JPL  
Mr. Robert E. Parks, Consultant  
Dr. Macgregor S. Reid, JPL  
Mr. Christopher J. Thompson, SAIC (Technical Recorder)  
Mr. Peter Vallandigham, Vitro Corporation

---

\*Interviewed by the Board

**THIRD MEETING: AUGUST 15-16, 1990  
HUGHES DANBURY OPTICAL SYSTEMS  
DANBURY, CONNECTICUT**

**A. SUMMARY**

The third meeting of the Board took place on August 15-16 at the offices of Hughes Danbury Optical Systems, Inc. in Danbury, Connecticut. The full Board and staff were again in attendance, including, as an observer, Dr. Robin Laurance of the European Space Agency.

In the interim since the second meeting, the Board continued to review pertinent documents as they were uncovered at HDOS and MSFC. Mr. Parks remained on-site at HDOS to oversee the noninvasive inspection of the primary mirror test equipment and to participate in the document search and review process.

The third meeting comprised status reports on visual inspections, document search and analysis, sensitivity analyses, and test planning. The meeting began with a closed Executive Session in which the Board discussed the status of the investigation. The open session began with an HDOS report on its review of recently recovered null corrector design documents. HDOS then reported on the completed sensitivity analyses of the HST OTA test equipment and procedures, which yielded a mathematically plausible source of the error as observed in the HST primary mirror. HDOS also reported on its visual inspection of the equipment in which this plausible error could have occurred, and gave a detailed presentation of the alignment procedures used on this equipment. Mr. Parks expressed his confidence in the analysis and inspection results, which pointed toward an observed lens spacing error in the reflective null corrector as the probable cause of the spherical aberration. The Board then reviewed the design and utilization of the reflective null corrector and ancillary measurement devices used in the procedures involving this equipment.

The Board at this point noted the emergence of two veins in its activity, one of which was the determination of causality of the flaw and its persistence prior to flight, which was becoming conclusive, and the second of which was the detailed characterization of the flaw for corrective purposes, which would require substantial further testing. Pursuant to the second activity, HDOS next presented some possible techniques for more precisely characterizing the aberration in the mirror, data which would be of use for the effort to design corrective lenses for the replacement flight optics for HST, and also reviewed their progress in setting

up a proof-of-concept simulation of a "wire test" they were proposing for the null correctors.

During the evening of the first day, the Board held a general discussion of the test philosophy and quality control techniques in place on the HST program at HDOS, and of what steps regarding certification of the null correctors would now be prudent as part of an effort to better characterize the flaw in the on-orbit primary mirror.

The second day of the meeting comprised revisiting the HDOS presentations from the first day, presentations by Board members on options for further testing, and a discussion among the Board members of how to organize the final report of the investigation. HDOS personnel presented further details regarding sensitivity analyses and test options as requested by the Board the previous day. Two Board members also offered options for further testing, including a temperature sensitivity analysis of the primary mirror test facility, as well as a primary mirror simulation technique. The Board, recognizing that the first vein of its activity, determining the cause and persistence of the flaw in the mirror, was moving toward conclusion, then addressed the organization of the final report and agreed upon a preliminary outline and writing assignments.

The third meeting of the Board concluded with plans to hold the next meeting in the middle of September, again at HDOS. Prior to adjournment, the Board reviewed a statement for the press regarding their progress thus far.

## **B. PARTICIPANTS**

All members of the Board were present, including, as an observer, Dr. Robin Laurance of the European Space Agency. Also in attendance:

### **NASA Headquarters**

Ms. Paula Cleggett-Haleim  
Dr. Charles Pellerin  
Mr. Gary Tesch

### **NASA/MSFC**

Mr. Ernie Deogracias  
Mr. F. Vernon Hudnut  
Mr. John Humphreys

Mr. Daniel Johnston  
Mr. James Lominick  
Mr. Joseph Randall  
Mr. Max Rosenthal

### **Hughes Danbury Optical Systems**

Mr. Robert A. Arnold  
Mr. George Bossers  
Mr. David Burch  
Mr. David Chadwick  
Mr. John Cunniff  
Mr. D. DellaValle  
Mr. R. Thomas Dubos  
Mr. R. Esposito  
Dr. Terence Facey  
Mr. William Freeman  
Ms. Laurie K. Furey  
Mr. Robert Harned  
Mr. Richard T. Kertesz  
Mr. Frank Krausz  
Mr. Malcolm MacFarlane  
Mr. Joseph Magner  
Mr. Fred A. Marra  
Mr. Tom McHugh  
Mr. David Olson  
Mr. William S. Raiford  
Mr. John D. Rehnberg  
Dr. John C. Rich

### **Hughes Corporation**

Mr. James Knotts

### **Staff to the Board**

Dr. James Breckinridge, JPL  
Mr. Robert E. Parks, Consultant  
Dr. Macgregor S. Reid, JPL  
Mr. Christopher J. Thompson, SAIC (Technical Recorder)  
Mr. Peter Vallandigham, Vitro Corporation  
Mr. William B. Wetherall, Optical Research Associates



**FOURTH MEETING: SEPTEMBER 12-13, 1990  
HUGHES DANBURY OPTICAL SYSTEMS  
DANBURY, CONNECTICUT**

**A. SUMMARY**

The fourth meeting of the Board took place on September 12-13 at the offices of Hughes Danbury Optical Systems, Inc. in Danbury, Connecticut. The full Board was in attendance, again including, as an observer, Dr. Robin Laurance of the European Space Agency. NASA Public Affairs Officer Ms. Sarah Keegan, who was unable to attend the third meeting, was again present. Mr. Gary Tesch, NASA Deputy General Counsel, did not attend. Dr. Macgregor Reid of JPL, who served as staff to Dr. Allen for the investigation, was unable to attend this meeting and was replaced by Dr. Katherine Dumas. Also in attendance, at the request of the Board, were Dr. C. R. O'Dell of Rice University, who was the HST Project Scientist at MSFC, and Dr. Daniel Schroeder of Beloit College, who was the HST Telescope Scientist. Both are still under contract to NASA.

A British Broadcasting Company film crew was permitted to briefly film the Board on the first day as part of a documentary on HST being produced for the NOVA television program. The Board held a press conference at HDOS on the afternoon of the second day to bring the press up-to-date on the status of the investigation.

At the August 15-16 meeting in Danbury, the Board had requested status updates on elements of the work plan, including reports on specific studies, measurements, and analyses.

In the interim since the third meeting, HDOS continued to perform measurements and analyses under the supervision of Mr. Parks. Also during this period, the Board members drafted submissions for the Board's final report, which were given to Dr. Allen for review. Information regarding all of these activities was transmitted to and among the Board members via datafax, as were some of the requested documents.

The first day of the fourth meeting comprised updates and discussions of ongoing tests, measurements, and related plans for characterizing the HST OTA primary and secondary mirrors. As at the previous meeting, particular attention was paid to the null correctors used in manufacturing and characterizing the primary mirror. In response to prior requests from the Board, HDOS reported on the following issues:

- (1) Progress in sensitivity analyses of the inverse null and of the refractive and reflective null correctors
- (2) Estimated cost, schedule, and performance parameters for building a new inverse null for the refractive null corrector
- (3) Analysis of the likely maximum error in the conic constant of the secondary mirror
- (4) Options toward a plan for more precisely characterizing the wavefront of the primary mirror. These wavefront data are needed by the teams that will build the replacement instruments for HST.

Also on the first day, the Board interviewed Drs. O'Dell and Schroeder to gain their insights into what was known, and by whom, about the primary mirror's figure during the manufacturing and test effort at HDOS. Mr. Fastie was interviewed by a teleconference call.

HDOS also presented an important discovery made during the week prior to this meeting. They found that the light beam used to reflect off the metering rod which spaced the field lens from the lower RNC mirror instead reflected off the field cap set on the end of the rod. The resulting change in the overall length of the metering-rod/field-cap assembly is quite close to the field-lens spacing error measured in the reflective null corrector.

## **B. PARTICIPANTS**

All members of the Board were present, including, as an observer, Dr. Robin Laurence of the European Space Agency. Also in attendance:

### **NASA Headquarters**

Ms. Sarah Keegan

### **NASA/MSFC**

Mr. John Humphreys  
Mr. Daniel Johnston  
Mr. Charles O. Jones  
Mr. Joseph Randall

Mr. Max Rosenthal  
Mr. Ed Trentham  
Mr. Fred S. Wojtalik

**NASA/GSFC**

Mr. H. John Wood

**Beloit College**

Dr. Daniel Schroeder\*

**Hughes Danbury Optical Systems**

Mr. Robert A. Arnold  
Mr. R. Thomas Dubos  
Dr. Terence Facey  
Mr. William Freeman  
Ms. Laurie K. Furey  
Mr. David Goux  
Mr. Howard D. Hall  
Mr. Richard T. Kertesz  
Mr. Malcolm MacFarlane  
Mr. Fred A. Marra  
Mr. Arthur Napolitano  
Mr. David Olson  
Mr. William S. Raiford  
Mr. John D. Rehnberg  
Dr. John C. Rich

**The Johns Hopkins University**

Mr. William Fastie\*\*

**Rice University**

Dr. C. R. O'Dell\*

## **Staff to the Board**

Dr. James Breckinridge, JPL

Dr. Katherine A. Dumas, JPL

Mr. Mark Kahan, Optical Research Associates

Mr. Robert E. Parks, Consultant

Mr. Christopher J. Thompson, SAIC (Technical Recorder)

Mr. Peter Vallandigham, Vitro Corporation

Mr. William B. Wetherall, Optical Research Associates

---

\*Interviewed by the Board

\*\*Interviewed by the Board via teleconference call

**ATTACHMENT 1**

**TO**

**APPENDIX B**

**HST INDEPENDENT OPTICAL REVIEW PANEL FINDINGS**

The conclusions that follow are based on information presented to the committee during briefings on July 5, 1990 at BDM in Columbia, Maryland.

**1. There is an approximate one-half wave rms spherical aberration residual in the Optical Telescope Assembly.**

There is no indication that this wavefront error comes from any source other than the OTA since it is observed in the WF/PC, the Faint Object Camera (FOC), and the wavefront sensors.

**2. The spherical aberration error cannot be corrected with any of the existing HST controls.**

**3. If coma and astigmatism are observed, they can be corrected with existing HST controls.**

In the presence of a large spherical aberration residual, the wavefront sensor may not be adequate to sense small amounts of coma and astigmatism. Coma and astigmatism may be detected with the upgraded instruments and hence correctable as required.

**4. Replacement instruments can be corrected for the spherical aberration error of the telescope assembly so that the original performance targets can be met.**

If the OTA surface which is in error can be identified, an even better job of redesigning the instruments can be done.

**5. An accurate knowledge of the spherical aberration error is required, but can be determined from the image characteristics sensed by various onboard instruments.**

The method of deconvolving imagery from the WF/PC and the FOC to provide the magnitude and sign of the spherical aberration error appears to be an effective and promising approach. An on-orbit test program which accumulates results for a large number of observations needs to be started immediately. All testing of this sort should be done with as narrow a spectral band as possible, and at wavelengths in the near infrared to permit a more accurate analysis of the fine structure in the images.

**6. The backup primary mirror should be tested using the HDOS and EK null lens optics. Measurement of the No. 2 secondary mirror should also be done to aid in identifying the source of the spherical aberration error.**

Testing the secondary will be the quickest way to isolate the source of the error, and to determine whether it came from the HST primary mirror or secondary mirror.

**7. To fully correct the spherical aberration of the OTA, some of the optical elements in the replacement instruments will need to be replaced or added.**

This should be a fairly simple task involving little more than changing the aspheric surface profiles of the reimaging optics.

**8. A replacement wavefront sensor having a wider dynamic range should be considered.**

The present unit functions poorly in the presence of such large amounts of spherical aberration.

**9. An OTA simulator which has a spherical aberration residual which is the same as the HST must be designed and fabricated so that the redesigned instruments can be tested prior to launch and installation in 1993.**

*Duncan Moore*  
Professor, Institute of Optics  
University of Rochester

*Paul Robb*  
Manager, Optical Sciences Lab  
Lockheed Palo Alto Research Labs

*Aden Meinel*  
Distinguished Scientist  
Jet Propulsion Laboratory

*George Lawrence*  
Professor, Optical Sciences Center  
University of Arizona

*Daniel Schulte*  
Senior Staff Scientist, Optical Design  
Lockheed Palo Alto Research Labs

*Dietrich Korsch*  
Optical Science Consultant  
Korsch Optics

## **APPENDIX C**

### **TUTORIAL ON SPHERICAL AND COMA ABERRATION**



## A. INTRODUCTION

The term "aberration" is used to describe an error within an optical system where a clear, sharp image does not appear at the image plane. Aberrations are divided into two classes based on what has to be done to the optical system to correct for the aberration and thus make a clear, sharp image. The easiest class of aberrations to correct for comprises tilt and defocus aberrations. These are corrected by realigning the optical elements and optical surfaces by tilting them and by refocusing the system to produce a clear, sharp image. The other class of aberrations, "higher-order" aberrations, is more difficult to correct. Examples of higher-order aberrations are spherical aberration and coma aberration. Spherical aberration occurs when light reflects from different points on the surface of the mirror and focuses at different places along the optical axis. Spherical aberration is present on the optical axis. Coma aberration appears in images off the axis. These aberrations cannot be corrected by using the simple procedures of tilt and refocus, but rather require either a change to the curved optical surfaces, which are figured into the solid glass, or the positioning of corrective lenses (similar to eyeglasses) within the light path.

## B. SPHERICAL ABERRATION

Spherical aberration is illustrated in Figure C-1. Figure C-1(a) shows a concave, spherical mirror. A point source object (not shown) is a large distance to the left. The optical axis is a line running through the center of curvature and passing through the spherical surface. The vertex is that point on the curved optical surface that is intersected by the optical axis.

Four optical rays from the entire bundle of optical rays that intersect the mirror are shown coming from the point source to the left. These rays are parallel to the optical axis. Two are shown close to the optical axis, and two are shown far from the optical axis.

In the case of a spherical mirror, the rays closest to the axis focus at a point farther from the mirror vertex than do those rays farther from the axis. The two rays close to the optical axis in Figure C-1(a) strike the mirror surface near the vertex of the mirror, reflect to the left, and converge, intersecting the optical axis at a point called the paraxial (or reference) focus. The two rays far from the axis and near the mirror edge reflect from the spherical mirror, travel to the left, and intersect the optical axis at a point called the marginal focus. The paraxial and marginal foci represent the extremes of a continuum of foci.

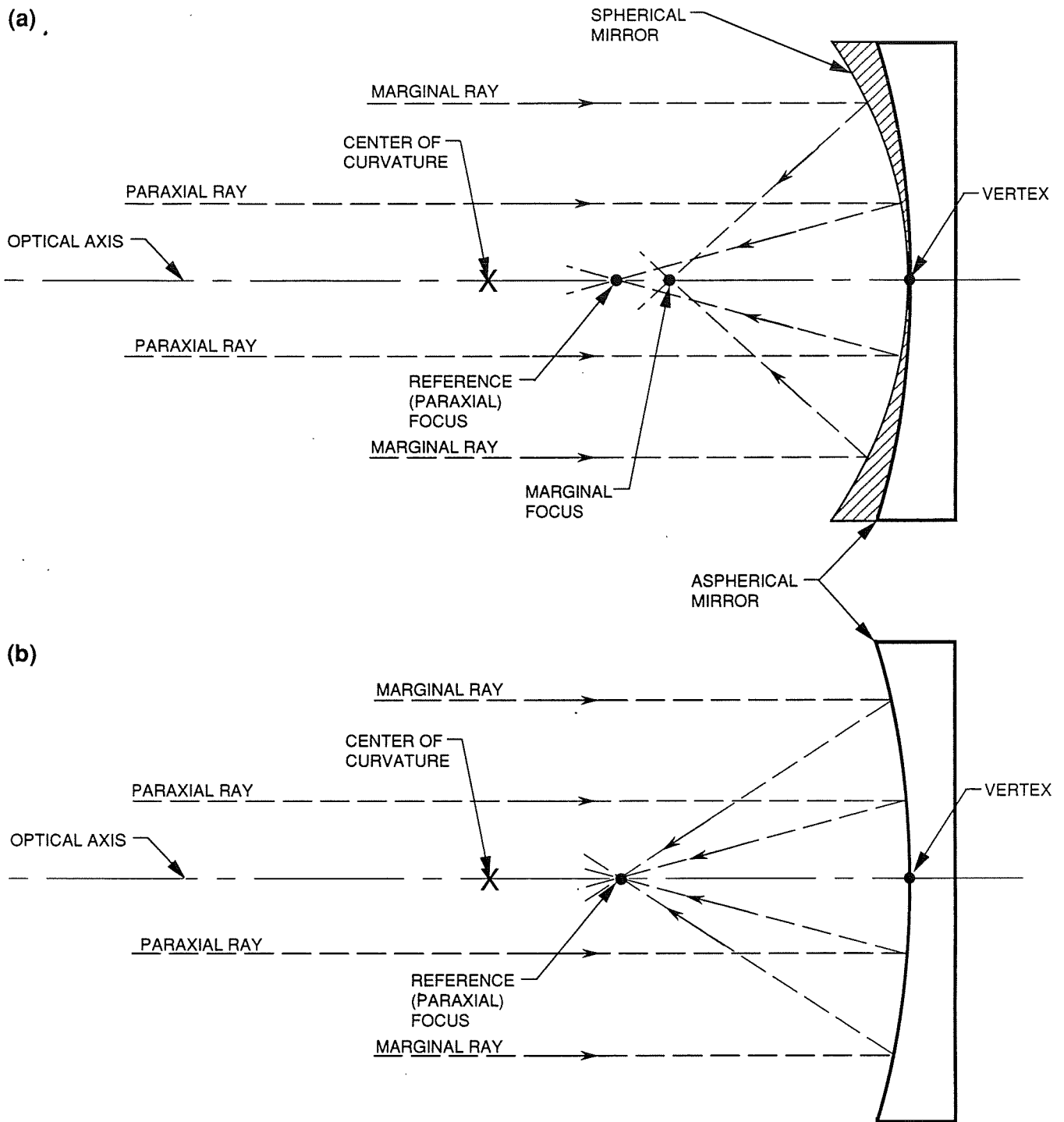

**Figure C-1. Light-path comparison between spheric and aspheric mirrors. (a) The perfectly spherical mirror shows light reflecting to the two extreme foci, causing spherical aberration. (b) To remove this spherical aberration, an aspheric mirror is created by grinding down the edges of the mirror.**

Note that the marginal focus is not the same focus as the paraxial focus. The difference between these two foci is the spherical aberration. Spherical aberration occurs when rays reflecting from different locations on the mirror focus light at different points along the optical axis. By convention, the sign of the spherical aberration shown in the Figure is positive, since the marginal focus is to the right of the paraxial focus.

If we put a mask over the optical system shown in Figure C-1(a) and let only rays close to the optical axis reflect from the concave mirror, the image will be a clear, in-focus point at the paraxial focus. In that case, we will have placed the opening of the mask over the center of the mirror, and made the light-collecting surface area smaller. This results in faint images of bright objects. Faint points of light (for example, faint stars) would not be recorded at all at the image plane. To increase the light-gathering ability of the mirror, the light-collecting surface area must be increased. Therefore, the diameter of the bundle of optical rays that reflects from the mirror is increased. As the aperture is increased, we admit rays to the system that are farther and farther from the optical axis. The marginal rays do not focus at the same point as the paraxial rays, and a blurred image appears. In no single position of the image plane is there a "best" focus. The image cannot be made sharp by refocusing the optical system.

### **C. CORRECTING FOR SPHERICAL ABERRATION**

To remove the spherical aberration from this system, we need to figure, or shape, the spherical mirror into a parabolic (aspheric) surface. To make the marginal rays cross the optical axis at the same focal point as the paraxial rays, the surface is figured into a parabola by removing material from the outer surfaces of the mirror, Figure C-1(b). The amount of material we need to remove increases with distance from the optical axis. The radius of the basic sphere (the aspheric surface's vertex radius) establishes the paraxial focal position: the process of figuring does not change this focus. Removal of mirror material results in superimposition of the marginal focus onto the paraxial focus.

### **D. FIELD OF VIEW**

A single point source contains limited scientific information, and it is therefore desirable to image across an area of the sky. The area of the sky from which the detector (or camera) receives light is called the field of view. The field of view can be affected by many factors: the aperture of the telescope, the size of the detector, and any intervening baffles or obstructions within the telescope assembly.

## **E. COMA ABERRATION**

We have seen that spherical aberration is caused by rays reflecting from different portions of the mirror and converging to foci at different points along the optical axis. Coma aberration occurs at a region off the optical axis in the field of the image where rays reflecting from different portions of the mirror form images at different points. Understanding the behavior of both spherical and coma aberration within the Hubble Space Telescope has provided us with useful diagnostic tools to determine how the error occurred.

Figure C-2 shows the character of perfect images, images with spherical aberration, and images with coma aberration. The small dot at the left of the Figure is representative of a perfect image of a point source. At the center of the Figure, the image of the point source is large and blurred, the way it appears at the image plane in the presence of spherical aberration. At the right of the Figure is shown the character of the point source with coma aberration: a point off the optical axis in the image-plane field. The coma image of the point source appears as a "V"-shaped figure. The tip of the "V" is bright and the other end appears to be a flaring of the light away from the tip.

## **F. CORRECTING COMA AND SPHERICAL ABERRATIONS ACROSS THE FIELD**

A telescope built with a single large mirror, either an asphere or a sphere, has a relatively small field of view for quality imaging; that is, image quality degrades rapidly as field angle decreases. To provide a high-quality, aberration-free image over a larger field of view than can be provided by a one-mirror system, a two-mirror optical system was selected for the Hubble Space Telescope. Reflecting the light from two aspheric mirrors gives the telescope enough degrees of freedom to correct aberrations across a field of view large enough to be of interest to scientists.

An optical system where the light reflects from two hyperbolic surfaces gives good correction for both spherical and coma aberrations over the field of view required for the HST. This optical design approach is called a Ritchey-Chretien design and was selected as optimum for the Hubble Space Telescope.

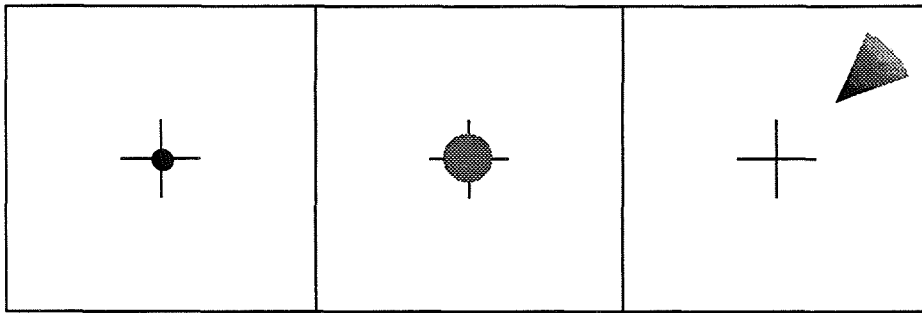

⊕ = OPTICAL SYSTEM AXIS

**Figure C-2. Image distortion due to spherical and coma aberration. Left: The small dot represents a perfect image of a point source. Center: The image grows and blurs in the presence of spherical aberration. Right: In the presence of coma aberration, the image appears V-shaped, bright at the tip and flaring away.**

The configuration for this two-mirror optical system is shown in Figure C-3. Four rays are shown entering the optical system: two near the axis (paraxial rays) and two far from the axis (marginal rays). The specific aspheres selected for each of the HST mirrors are hyperbolas of revolution about their axes. By making both mirrors hyperbolic surfaces, the coma and spherical aberrations can be corrected over the desired field of view. The form of the primary mirror (the mirror that light strikes first) is concave. The form of the secondary mirror is convex. If the two hyperbolas are manufactured perfectly, then the telescope is well corrected over a relatively large field of view.

The primary mirror is generally figured with a hyperbolic surface by using methods similar to those discussed above for the parabolic surface. That is, the surface is figured into a hyperbola by removing material from the outer surfaces of the mirror. The amount of material we need to remove increases with distance from the optical axis. The radius of the basic sphere (the hyperbolic surface's vertex radius) establishes the paraxial focal position.

In the case of the HST, the "template" (the reflective null corrector) used to provide the reference surface for figuring the primary mirror, was not correct. In Figure C-4, we show an enlarged view of the marginal and paraxial rays as they converge in the vicinity of the vertex of the HST. Figure C-1 was used to show how the marginal focus could be superimposed on the paraxial focus by removing material. In the HST, too much material was removed from the outer edges of the primary mirror, and the marginal focus was moved to the right, past the paraxial focus. Since the marginal focus is to the right of the paraxial focus, the sign on the error is negative. Since more material than necessary was removed, the opticians call this situation "overcorrected" spherical aberration.

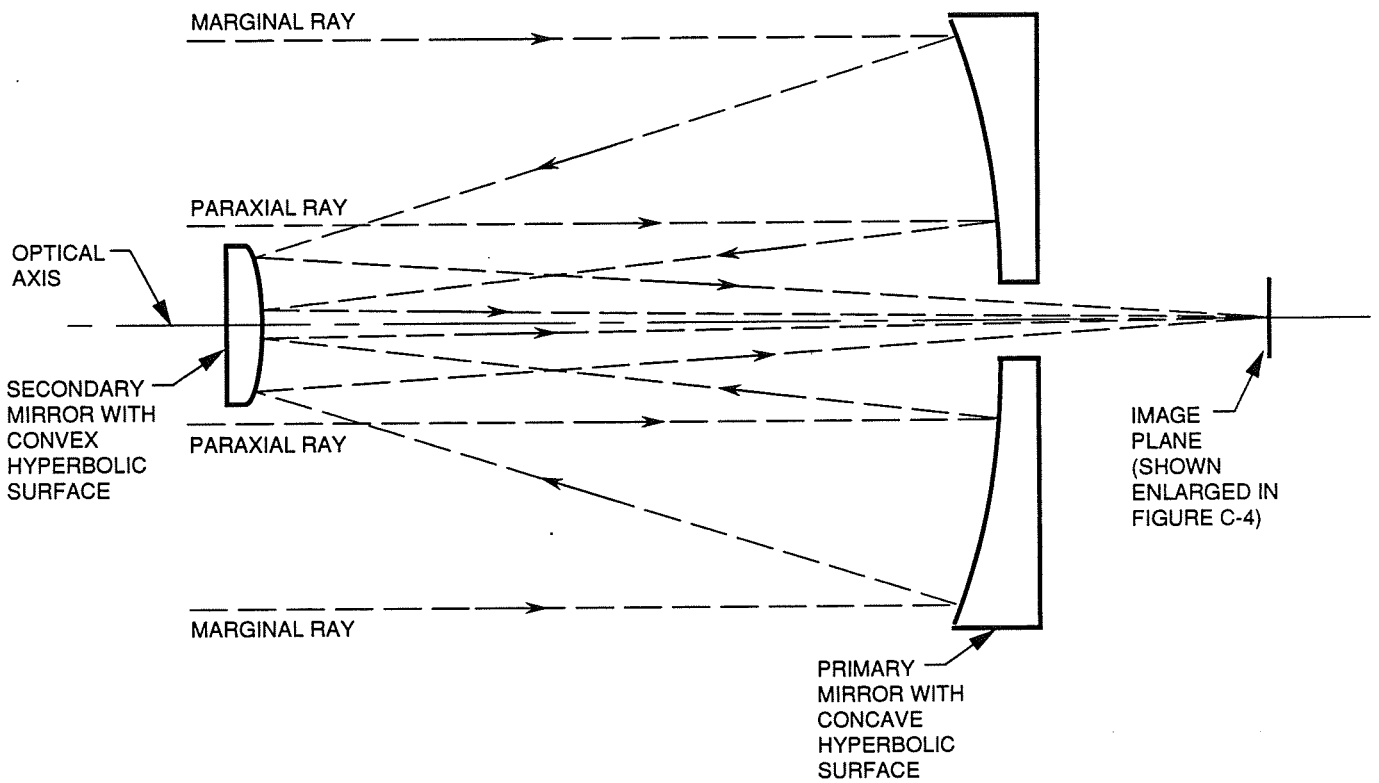

**Figure C-3. The HST's Ritchey-Chretien optical system. Two hyperbolic mirrors are used to correct for spherical and coma aberrations.**

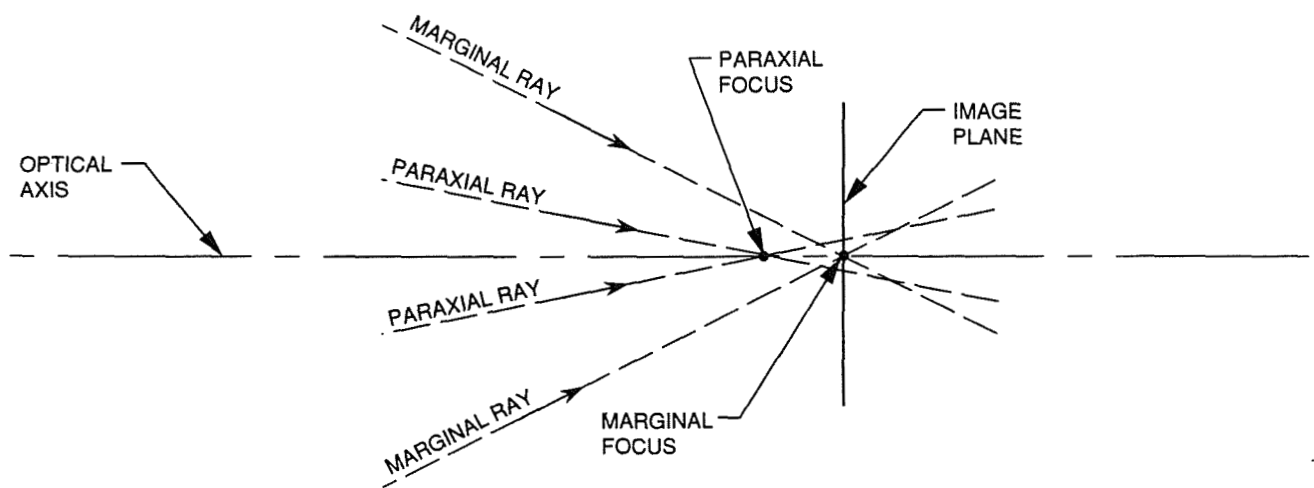

**Figure C-4. Image-plane enlargement of the HST Ritchey-Chretien optical system. In the HST, too much material from the edges of the primary mirror was removed, and the marginal focus was moved past the paraxial focus. This is characteristic of an optical system overcorrected for spherical aberration.**



## **APPENDIX D**

### **DESCRIPTIVE SUMMARY OF INTERFEROGRAMS**

## DESCRIPTIVE SUMMARY OF INTERFEROGRAMS

The principal evidence to identify the error in the Hubble Space Telescope's Optical Telescope Assembly is obtained from the interferograms acquired during testing, along with coordinated analysis based upon the actual, as built, measurements of the null correctors. In this Appendix, the principal interferograms are presented, along with a description of their importance and implications toward defining the error in the telescope.

Interferometry was the test choice for evaluating the mirror because of the intrinsic accuracy of mapping the mirror surface by using light within the wavelength bandwidth used in the telescope. The fringe patterns from the interferograms were analyzed by digitization into contour maps and subsequently evaluated by computer against numerical criteria for acceptance. The interferograms were also made and used repeatedly to obtain information about the progress during fabrication, as well as being used as a gauge in determining the final quality of the mirror surface.

Generally, the optical-path error between successive dark fringes in an interferogram indicates a path difference of one wavelength. Reflection from the mirror surface causes each fringe to indicate a surface-height error of one half of a wavelength on the surface of the primary. A different, double-pass test configuration divides this interpretation in half for the secondary mirror's interferogram.

At the time of fabrication of the HST optics, the method used in interferometry was to adjust the interferometer to introduce tilt, and thus many parallel fringes, into the aperture. These interferograms were photographed and scanned on a microdensitometer to digitize the locations of the fringe centers for computer mapping and analysis.

Current technology primarily uses high-speed video collection and on-line computer analysis of interferometric data. Real-time interferometer technology was at its infancy during the HST fabrication, and thus was not used on the telescope.

### A. FINAL TEST OF THE PRIMARY MIRROR

Figure D-1 is an interferogram taken through the reflective null corrector in February 1982 of the primary mirror fabricated by Perkin-Elmer Corporation at the completion of the processing of that mirror. The interferometer was adjusted to provide a large number of fringes to obtain complete coverage of the surface of

the primary mirror. The interpretation of this fringe pattern is that each fringe represents a surface error on the mirror of one half of a wavelength of helium-neon (He-Ne) laser light. A perfect mirror should provide straight, equally spaced fringes in the adjustment of the interferometer used in testing. Deviations from straightness or unequal spacing indicate flaws in the mirror.

The interferogram shows essentially straight fringes with only minor deviations of the wavefront from perfection. This interferogram was analyzed by Perkin-Elmer to indicate a residual surface error of less than 0.014 wave rms at 632.8 nm, or a surface smoothness of 0.009  $\mu\text{m}$  rms. The testing process used a Coaxial Reference Interferometer (CORI), which was capable of producing extremely high-quality fringes and used a He-Ne laser as the source. This analysis convinced the Project that the goals of the fabrication had been achieved.

The dark area in the center of the picture corresponds to the central hole in the primary mirror, and is almost exactly matched by the central hole in the reflective null corrector (RNC). There is a small chip in the lower mirror of the RNC that shows up as an irregular area on the interferogram.

It is now known that at the time the reflective null assembly contained about a 1.3-mm spacing error for the field lens and, consequently, was producing a null wavefront that did not match the desired hyperbolic form. Therefore, close correspondence of the fringes actually indicates a very close match to the wrong aspheric surface. The symmetry of the fringe pattern indicates that the error is also symmetrical and corresponds to a spherical aberration error.

An analysis of the best available data from the test records and the as-built information from the tests indicates that the actual aspheric mirror would produce a third-order spherical aberration wavefront error of about 0.4 wave rms at 632.8 nm.

This interferogram shows three circular obscurations that cover penetration holes in the mirror surface. The obscurations were not directly part of the mirror support system, but they covered catch plates that would keep the mirror from breaking loose of the mount and damaging portions of the space shuttle orbiter, should the shuttle have had to abort the flight and return to Earth in an emergency landing. The fringe pattern also indicates the presence of local, sharp surface errors that actually fall outside of the clear aperture being used in the telescope. The semicircular marks at the periphery are fiducials used to locate the aperture in the fringe digitization process. The other defects indicated in the picture are glass chips and marks attached to components in the reflective null corrector.

ORIGINAL PAGE  
BLACK AND WHITE PHOTOGRAPH

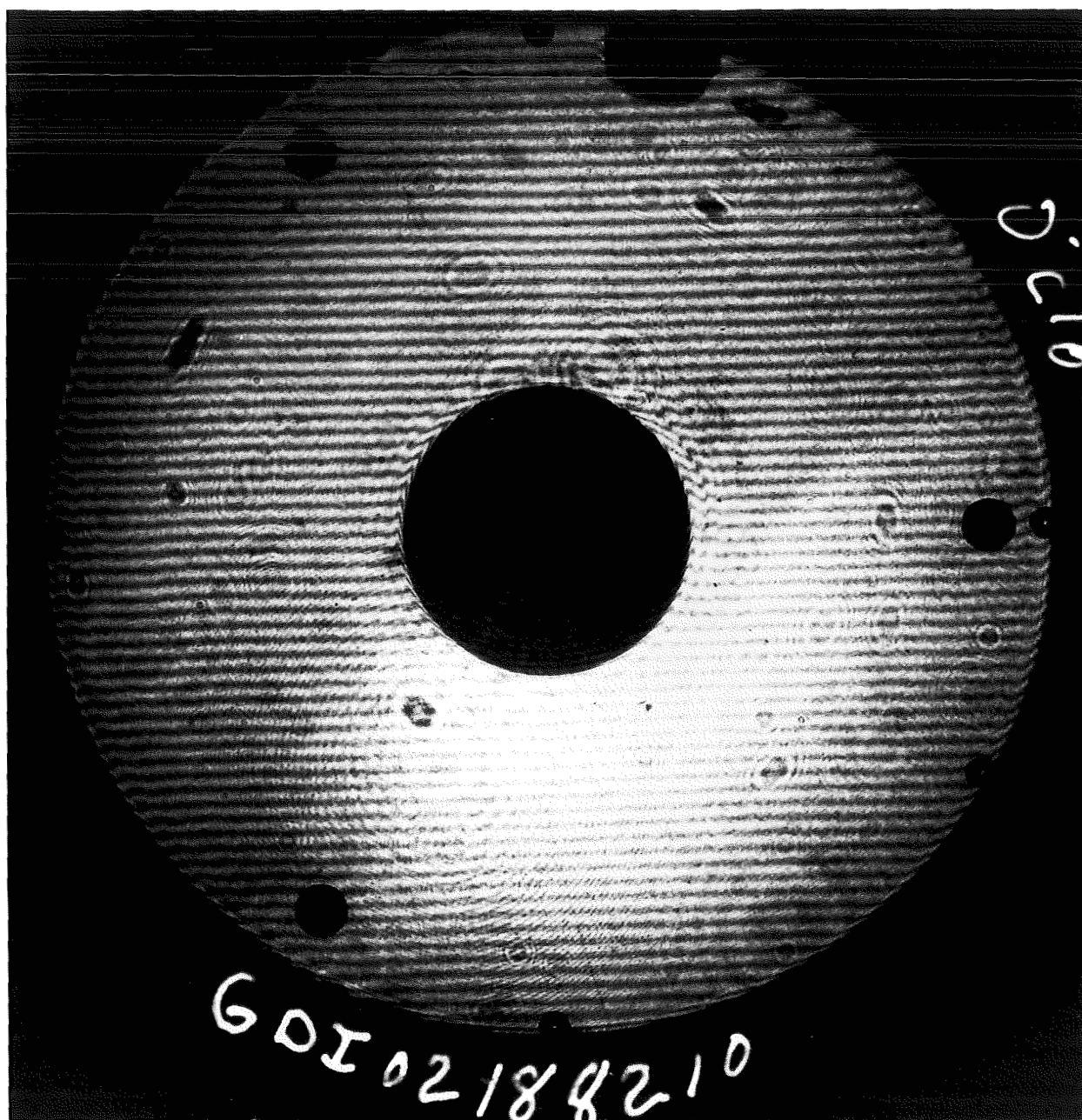

**Figure D-1. RNC interferogram of the primary mirror, taken in February 1982.**



During this test, the primary mirror was resting on a flotation mount designed to provide an artificial "zero-gravity" condition by supporting the mirror uniformly on 128 mechanically loaded support points. The process of testing required that the primary mirror be adjusted upward toward the RNC until straight fringes could be observed. In the test procedure used, the focus of the system was adjusted during the process by changing the location of the primary, while the components of the RNC and interferometer were held fixed. The lengthy distance from the RNC to the mirror was not precisely measured.

## **B. REFRACTIVE NULL CORRECTOR TEST OF THE PRIMARY MIRROR**

Figure D-2 is an interferogram of the primary mirror taken through the refractive null corrector (RvNC) in May 1981. The curvature of the fringes indicates the presence of an error in the primary mirror, analyzed recently to be 0.4 wave rms at 632.8 nm third-order spherical-aberration wavefront error. This error matches to a reasonable level of certainty the error existing in the flight telescope. This value also matches well the spherical aberration calculated to be caused by the mistake in the assembly of the reflective null corrector.

The interferogram was taken using a common path interferometer, which does not provide as high-contrast fringes as does the Coaxial Reference Interferometer on the RNC. The original purpose in performing the test was limited to obtaining data on the base radius (for defining the focal length) of the primary mirror based upon comparison with a calibrated spherical test plate. The common-path interferometer was used with a broad-spectrum light source and visual observation to validate the absolute path matching between the primary mirror and the spherical reference mirror, which appears in the center of the hole in the primary. The difference in curvature between the central reference sphere and the primary mirror fringes in the zone nearest the hole was used to measure the radius of curvature of that inner zone.

The fringe pattern shown in Figure D-2 was obtained using a He-Ne laser as the light source. The experimental conditions in the setup produced a grainy, speckled pattern. The bright, washed-out region near the edge of the primary hole is due to the use of a common-path reference for the interference. The interpretation of the fringes is the same as in Figure D-1, with each fringe indicating a one-half wavelength of surface error in the mirror.

The fringes in the RvNC were not interpreted at the time of the original testing of the primary mirror. It was believed at the time that there were some errors in the RvNC, which led to less confidence in the data from that corrector. The purpose of using the RvNC for the radius test was to permit continuous viewing of fringes across the entire aperture.

Although the spherical aberration is clearly evident in Figure D-2, the intention in the test procedure was only to provide a straight fringe reference in the inner portion of the mirror, and no attention was to be paid to the curve fringes. Computer evaluation of these fringes in 1990 by several different observers led to the determination of the 0.4-wave rms wavefront error at 632.8 nm third-order spherical aberration.

### **C. INVERSE NULL CORRECTOR FRINGES**

The interferogram in Figure D-3 shows a set of fringes obtained from the inverse null corrector (INC) assembly through the RNC in 1981. The analysis of fringe data taken in 1981 and 1990 (see Chapter VI) shows that when the lateral shift adjustment for the position of the INC is accounted for, there is excellent correlation of the wavefront errors implied by the INC. This indicates not only the fundamental error in the RNC, but also the excellent stability of the entire CORI INC assembly.

The inverse null was designed to provide a simulation of the primary mirror. If all had gone well, the presence of straight fringes in the use of the INC would have indicated a perfect setup of the RNC. As is noted, the fringes were not straight, and indicate the presence of several waves of spherical aberration in the wavefront. The amount is comparable to, and of the opposite sign as, the amount observed in the telescope.

The actual use of the INC during testing was as an aid in alignment of the RNC system, and the INC was swung into position below the RNC at the beginning and end of each test sequence. The technicians used the INC fringes as a qualitative check upon the condition and alignment of the RNC, but the fringe pattern was apparently not fully evaluated at any time during the test period. It was known that the components of the INC were very sensitive to alignment, and also that there was a probable spacing error in the INC. Subsequent analysis has indicated that this error is of small magnitude.

The consistency of the data from the INC and the RvNC indicates the presence of the error in the RNC. The excellent agreement of the INC data taken in 1981 and similar data taken in 1990 indicates the excellent stability of the RNC.

ORIGINAL PAGE  
BLACK AND WHITE PHOTOGRAPH



PO-167250 F37

**Figure D-2. RvNC interferogram of the primary mirror, taken in May 1981.**





ORIGINAL PAGE  
BLACK AND WHITE PHOTOGRAPH

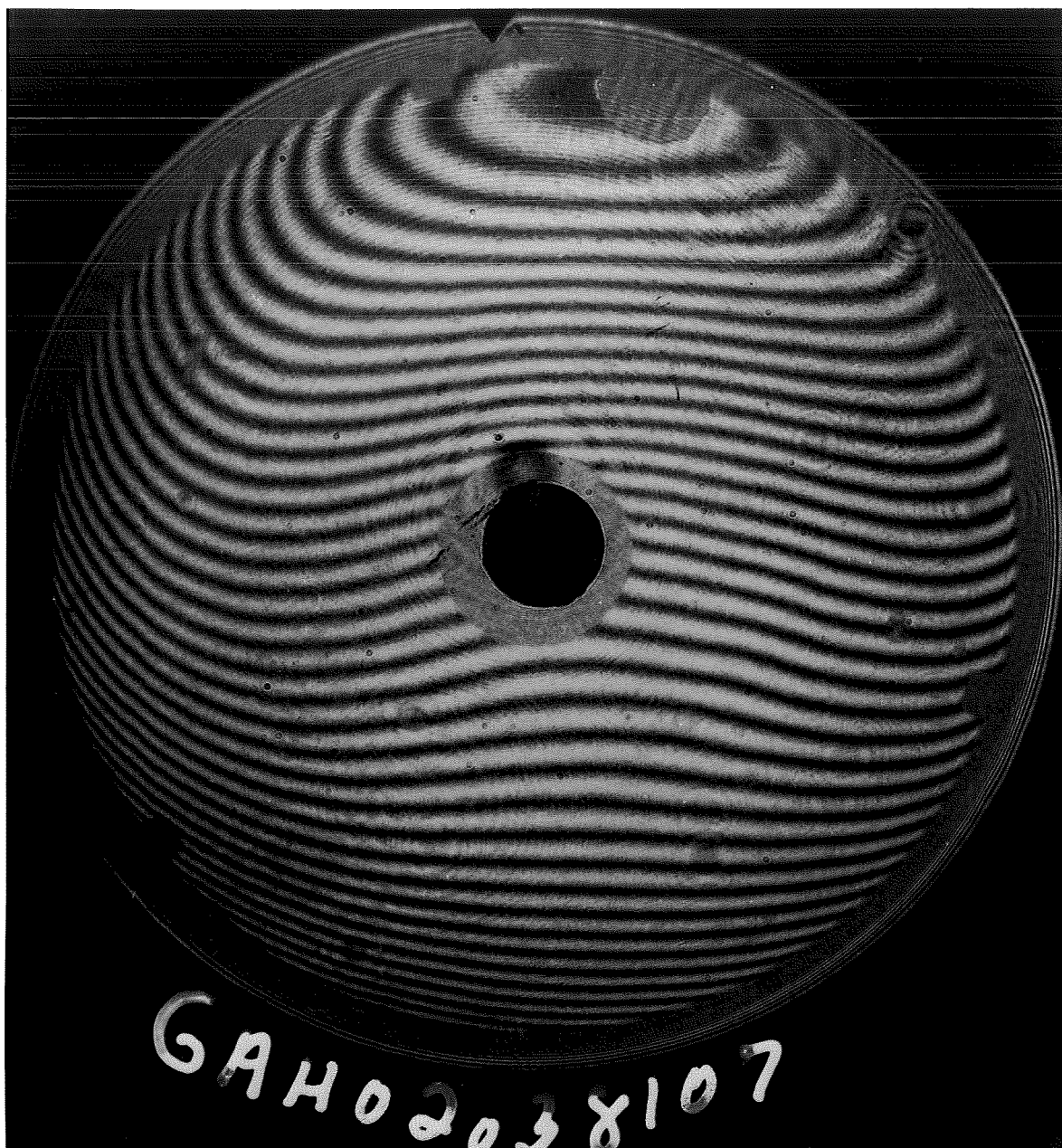

**Figure D-3. INC interferogram of the reflective null corrector, taken in February 1981.**

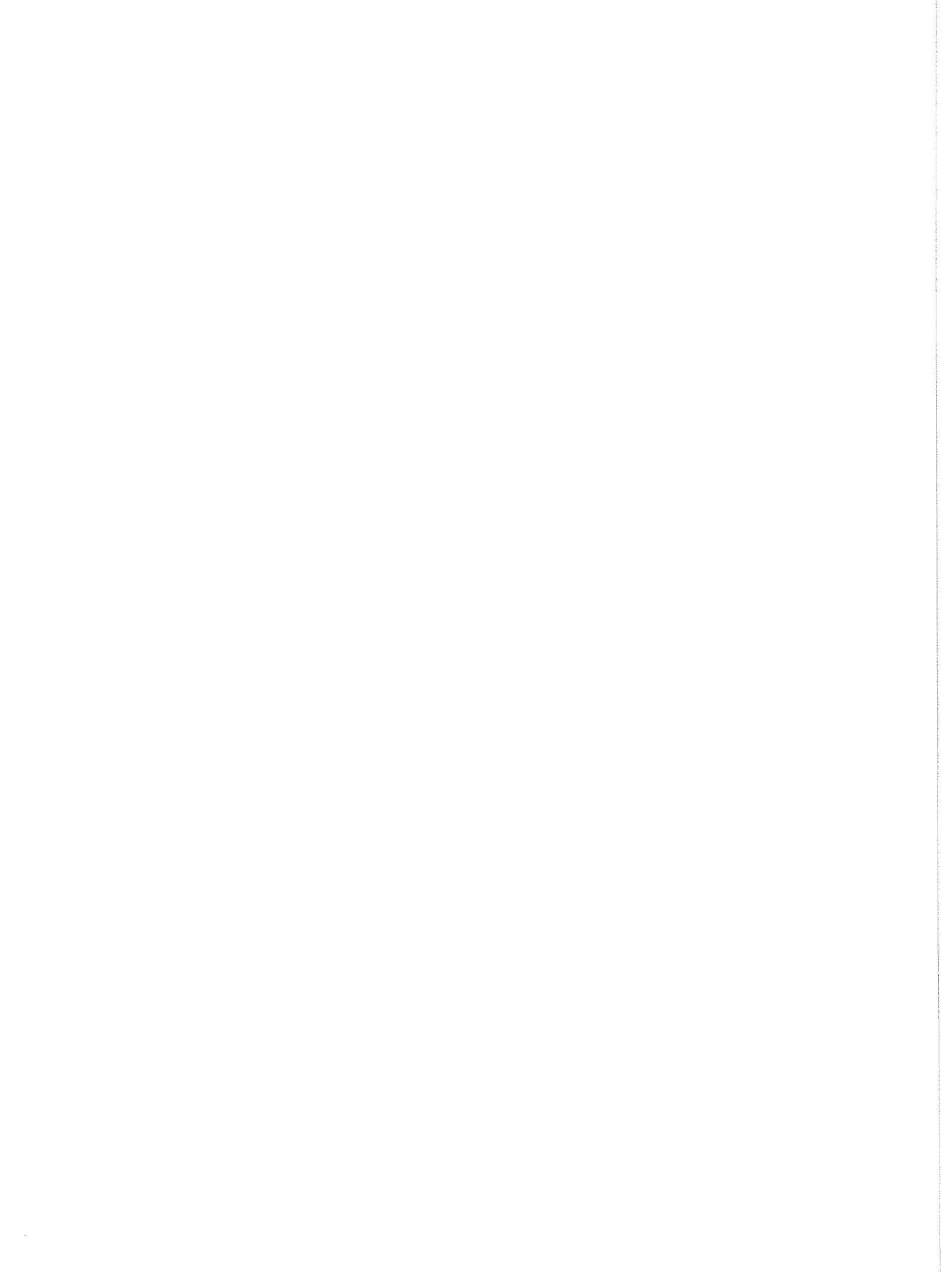

#### D. SECONDARY MIRROR TEST INTERFEROGRAM

Figure D-4 is one of a set of interference fringes obtained from the flight secondary mirror at the completion of fabrication. A Hindle Shell test, which uses a double bounce off the surface of the secondary mirror, produced a distance between fringes corresponding to a surface-height variation of 0.25 wave. The secondary mirror is quite smooth, with an rms surface error of 0.012 wave. The small circular zones have an error of about 0.018 wave peak-to-valley at 632.8 nm. Because of the double bounce, the appearance of the fringes doubles the effective wavefront error that this component introduces into the system.

An interferogram alone cannot be used to determine the absolute surface shape, that is, the radius and conic constant, of the mirror. The adjustment of the test setup must be controlled to determine this base surface. However, in the fabrication process, the aspheric surface figure was tested by fringe counting against a standard spherical test plate. The setup parameters of the Hindle Shell test were dimensionally controlled to set the absolute conjugates, thereby controlling the reference asphericity of the secondary mirror. The interferogram in Figure D-4 shows essentially no residual spherical aberration. This independent verification during fabrication makes it plausible to assume that no gross error in asphericity exists. Test data analysis at the time concluded that the tolerances had been met.

Analysis of this interferogram in 1990 supports, with only minor differences, the predicted quality of the surface shape.



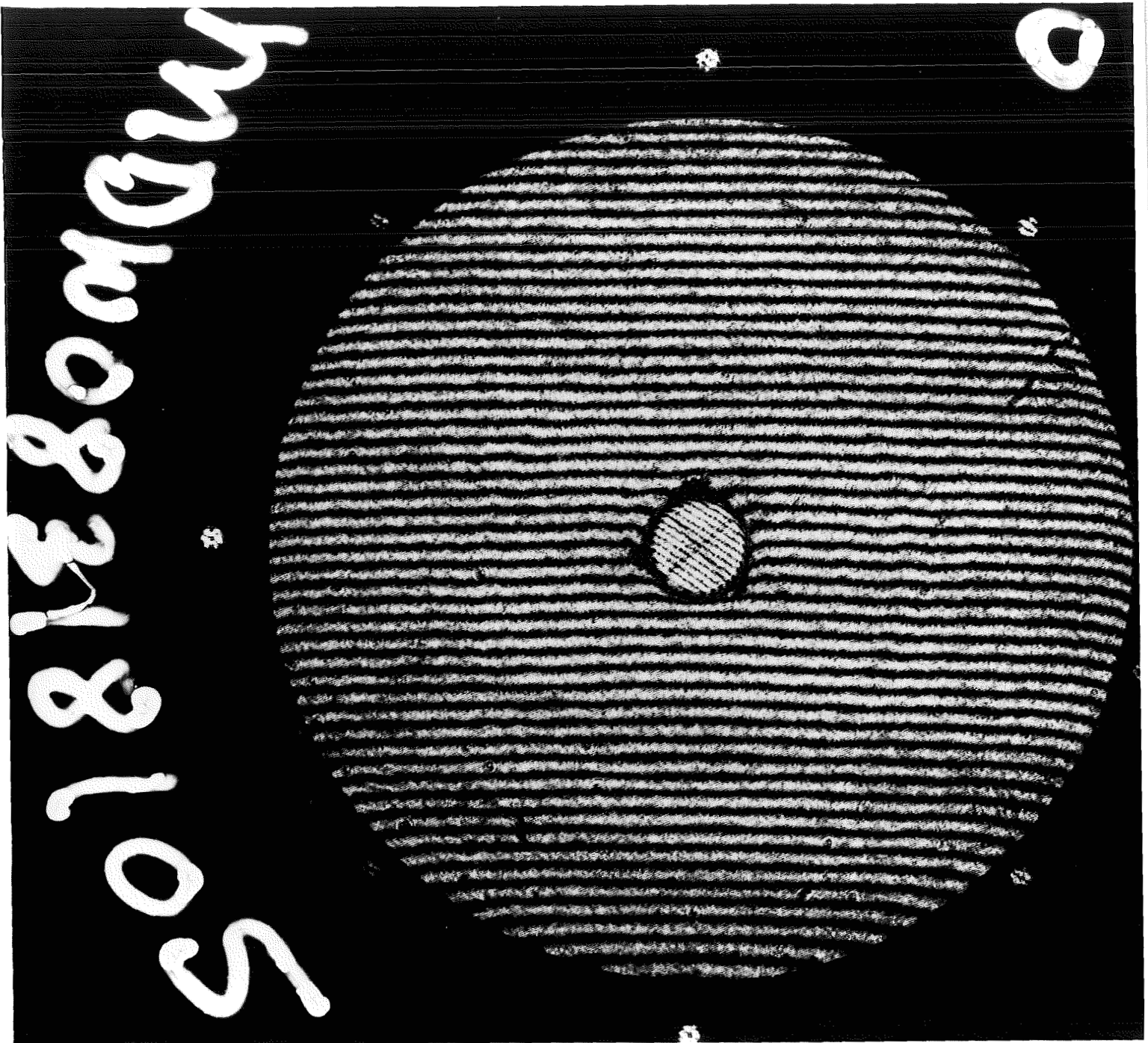

Figure D-4. Hindle Shell interferogram of the secondary mirror, taken August 31, 1981.

**APPENDIX E**

**HUBBLE SPACE TELESCOPE**

**PERFORMANCE BASED ON AS-BUILT DATA**

## HUBBLE SPACE TELESCOPE PERFORMANCE BASED ON AS-BUILT DATA

The HST is a two-mirror Ritchey-Chretien telescope whose nominal optical design is completely described by the parameters in Table E-1. (All these parameters have tolerances, and the HST will image imperceptibly less well than the ideal design of Table E-1 if the parameters drift slightly from that ideal design.) Table E-2 gives the measured values of the parameters in Table E-1 in the as-built condition. The as-built condition takes into account errors in the measuring equipment, as well as small errors in the actual measurements. The numbers in Table E-1 represent the best estimate as to the "truth" of these parameters.

The as-built conic constant in Table E-2 is derived from a combination of analyses performed over the last several months of the refractive null corrector (RvNC) interferograms (Figure D-2), the inverse null corrector (INC) interferograms (Figure D-3), and of the optical design as to the effect of the measured error in field lens position.

A comparison of the differences in these two tables leads to the following observations about the HST imaging performance:

- (1) If the HST had been built to the ideal design of Table E-1, the images would have been diffraction-limited, or theoretically perfect, within the bounds of the laws of physics.
- (2) If the HST had been assembled from the as-built components in Table E-2 with the design-value conic constant on the primary mirror and "perfectly" polished surfaces, the images would still have been ideal.
- (3) Because it is impossible to polish the mirror surfaces "perfectly," there is some degradation from ideal performance. When the residual (but within specification) polishing error is included as part of the as-built parameters, the imaging performance falls within 95 percent of ideal or diffraction-limited performance. This would still have resulted in over 70 percent of the light from a single star falling within a circle of 0.1-arcsecond radius, precisely as the specification called for. (Notice that the small degradation from ideal performance has to do with residual polishing errors that are expected in any telescope and not from any design problem.)



**Table E-1. HST OTA paraxial design parameters.**

Parameter	Value
Primary Mirror	
Radius, mm	11,040.0 (concave)
Conic constant	-1.0022985
Working aperture, mm	1,200.0
Secondary Mirror	
Radius, mm	1,358.0 (convex)
Conic constant	-1.49600
Spacings	
Back focal plane, mm behind primary vertex <sup>a</sup>	1,500.0
Primary–secondary separation, mm	4,906.072
Derived first-order parameters	
Magnification	10.434569
System f/number	24.00125

<sup>a</sup>Location set by instrument package.

**Table E-2. HST OTA paraxial as-built parameters.**

Parameter	Value
Primary Mirror	
Radius, mm	11,041.70 (concave)
Conic constant	-1.013236 <sup>a</sup>
Working aperture, mm	1,200.0
Secondary Mirror	
Radius, mm	1,358.065 (convex)
Conic constant	-1.49600
Spacings	
Back focal plane, mm behind primary vertex <sup>b</sup>	1,500.0
Primary–secondary separation, mm	4,906.888
Derived first-order parameters	
Magnification	10.43532
System f/number	24.00666

<sup>a</sup>Note: The primary mirror conic constant is the actual conic constant now on the mirror, due to the null corrector spacing error.

<sup>b</sup>Location set by instrument package.

- (4) If the as-built error in conic constant on the primary mirror (Table E-2) is added into the telescope design, the result is the third-order spherical aberration observed in the HST wavefront on orbit.
- (5) This unwanted third-order spherical aberration also shifts the position of best focus farther away from the back of the primary mirror.
- (6) Since the instrument package is fixed in space, this small focus error can be corrected by moving the secondary mirror slightly.
- (7) The total third-order spherical aberration is, however, affected by changing the secondary mirror spacing, which results in a small correction to the observed error.
- (8) When all these considerations are taken into account, at the best focus position, that is, the focus position that minimizes the rms wavefront error or puts the maximum energy into the central core of the image, 70 percent of the light from a single star is contained in a circle of about 0.7 arcsecond in radius (Figure 5-1).
- (9) The rms wavefront error at this best focus position is 0.4 wave at a wavelength of 632.8 nm, the wavelength at which the telescope was tested. Since the telescope is used over a broad wavelength range, it is perhaps better to say that the rms wavefront error is 0.253  $\mu\text{m}$  at best focus.

While the Board considers the above analysis to be correct, and has included it for informational purposes, it must be considered preliminary and should not be used for the design of new instruments or other critical purposes for several reasons:

- (1) It was not in the Board's charter to quantify the error beyond the degree necessary to be certain that the source of the error had been isolated, and thus time was not taken to do so more precisely.
- (2) The measurements made on hardware during the investigation were made to an accuracy sufficient to verify the source of the error but not with sufficient accuracy to give a definitive value for the spacing error.

- (3) There is still some confusion, because of a lack of documentation, as to the exact sizes of apertures, central obstructions, and fiducial locations needed to get definitive results from the analyses of extant interferometric data. It is easy to determine the shape of the wavefront from these data, but the magnitude of the spherical aberration depends sensitively on the exact aperture over which it is evaluated.
- (4) The definitive prescription for the HST wavefront must come from a careful weighting of all the various sources of data, including orbital data.