

*Dedicated to  
Craftsmanship!*

# **ASTRO** **PHYSICS**

*State-of-the-Art Instruments*

*for Discriminating Astronomers*

## **1200GTO GERMAN EQUATORIAL WITH GTOCP3 SERVO MOTOR DRIVE**

**FOR MOUNTS SHIPPED STARTING IN DECEMBER, 2009**

**AND ALL PREVIOUS 1200GTO MOUNTS**

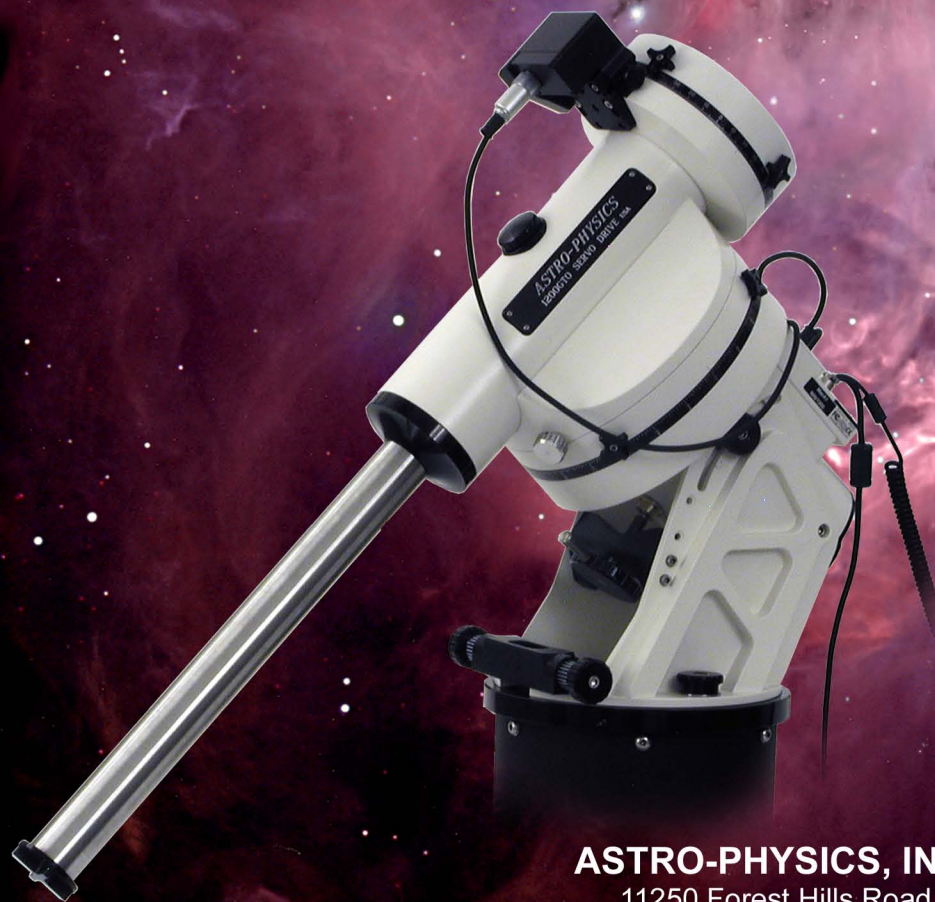

### **ASTRO-PHYSICS, INC.**

11250 Forest Hills Road  
Machesney Park, IL 61115  
Telephone: (815) 282-1513  
Fax: (815) 282-9847  
support@astro-physics.com  
www.astro-physics.com

January 8, 2010

# **ASTRO-PHYSICS**

## **1200 GERMAN EQUATORIAL WITH GTO SERVO MOTOR DRIVE**

ABOUT THIS MANUAL	3
MODEL 1200GTO PARTS LIST – MODEL GTOCP3	4
FEATURES AND SPECIFICATIONS	5
INTRODUCTION	6
Why Polar Alignment is Important	6
ASSEMBLY DIAGRAM	7
BEFORE YOU LEAVE HOME	8
Gross Latitude Adjustment for 1200GTO German Equatorial Mounts	8
Attach Pier Adapter to Pier Post (purchased separately)	10
Standard Pier Adapter (1200SPA)	10
Precision-Adjust Rotating Pier Adapter with Azimuth Bearing (1200RPA)	11
Hi-Lo Latitude Wedge Pier Adapter Assembly (1200WDGA) or Wedge Alone (1200WDG)	12
for 0°-22° or 69°-90° Latitude – North or South	12
AT YOUR OBSERVING SITE	13
Assemble Pier (purchased separately)	13
Assemble Polar Axis Assembly to Pier or Tripod	13
Polar Alignment – Part 1 – Rough Alignment	14
Altitude and Azimuth Adjustments - Rough polar alignment	14
Assemble Declination Axis	15
Removing Declination Axis at the End of Your Observing Session	16
Attach Mounting Plate (purchased separately)	16
18" Flat Mounting Plate (FP1800)	16
15" Ribbed Mounting Plate (1200RP15)	16
24" Ribbed Mounting Plate (1200RP)	16
8.5" Dovetail for Losmandy D Series Plates (DOVELM2)	17
16" Dovetail for 1200 Mounts and Losmandy D Series Plates (DOVELM16)	17
16" Easy-Balance Dovetail for Mach1GTO, 900 and 1200 mounts and Losmandy D Series Plates (DOVELM162)	17
15" Astro-Physics Dovetail (DOVE15) for 15" Sliding Bar (SB1500)	17
Attach Counterweight Shaft and Counterweights	18
Attach Mounting Rings and Scope (purchased separately)	18
Polar Alignment – Part 2 - Fine Polar Alignment	18
Methods for fine polar alignment	18
Altitude and Azimuth Adjustments	20
Fine Altitude Adjustment	20
Tips for Adjusting the Altitude	20
Fine Azimuth Adjustment	20
Precision-Adjust Rotating Pier Adapter with Azimuth Bearing (1200RPA)	21
Standard Pier Adapter (1200SPA) and Hi-Lo Latitude Wedge (1200WDGA)	21

<b>CLUTCH KNOBS AND BALANCING</b>	<b>22</b>
Understanding the R.A. and Dec. Clutch Knobs	22
Balancing Your Telescope	22
First, Balance the Declination Axis	22
Second, Balance the Polar Axis	23
<b>SERVO MOTOR DRIVE</b>	<b>24</b>
GTO Control Box – Model GTOCP3	24
Pre-loaded PEMPro™ Curve	24
Lead-Free Electronics	25
R.A. and Dec. Cable Connections	25
12V Connector	25
POWER Indicator Light	25
KEYPAD Connector	25
RS-232 Connectors	25
FOCUS Connector	26
RETICLE Connector	26
AUTOGUIDER Connector	26
+6V Connector	26
N and S Switch	27
Drainage Holes	27
Removing the GTO Control Box From 1200 Mount	27
<b>CONTROLLING YOUR GTO MOUNT</b>	<b>28</b>
GTO Keypad Operation	28
Pulseguide by Sirius-Imaging	28
PEMPro V. 2.x (latest release) by Sirius-Imaging	28
The Astro-Physics ASCOM V2 Driver	28
<b>CABLE MANAGEMENT</b>	<b>29</b>
1200 Motor Cables	29
Accessory Cables	29
Optional Accessories to Prevent Cable Snags	29
Example from International Space Station – Amateur Telescope (ISS-AT) Project	30
<b>SLEWING YOUR MOUNT IN BELOW FREEZING TEMPERATURES</b>	<b>31</b>
<b>MOUNT CARE, CLEANING AND MAINTENANCE</b>	<b>32</b>
Care	32
Cleaning and Touch-up	32
Routine Mount Maintenance	32
<b>TROUBLESHOOTING, TIPS AND SUPPORT</b>	<b>33</b>
Troubleshooting and Tips	33
Additional Support	35
<b>STANDARD PIER ADAPTER OF THE 1200 MOUNT</b>	<b>36</b>
<b>CLUTCH PLUG REPLACEMENT FOR 900 OR 1200 MOUNT</b>	<b>37</b>
<b>CONSTRUCT YOUR OWN CLUTCH PLUG EXTRACTION TOOL</b>	<b>38</b>
<b>CHARACTERIZING THE DEC AXIS MOTIONS</b>	<b>39</b>
<b>ASTRO-PHYSICS MOUNTING PLATE FASTENER CHART</b>	<b>40</b>

# **ASTRO-PHYSICS**

## **1200GTO GERMAN EQUATORIAL WITH GTOCP3 SERVO MOTOR DRIVE**

### **ABOUT THIS MANUAL**

This version of the 1200GTO Manual was prepared for the production run of mounts that began shipping in December of 2009. Most of the information in this manual is applicable to all 1200GTO's that have been produced. Some of this information was simply not available when the first 1200GTO's left our factory back in 1998. This includes information on newer accessories for the mount that weren't available for the first production runs. We have also learned a few things through experience and suggestions from our customers that have improved the content that is available in this manual.

We suggest that all 1200GTO owners adopt this manual for regular guidance with their mounts. The benefits of the improved information should easily outweigh the minor differences between mounts from earlier production runs and the current one. There will be a few things like the included serial cable, the GTOCP3 Servo Control Box and the Heavy Duty Azimuth Adjuster that owners of older mounts will not have. In a similar fashion, owners of brand new mounts should be aware that some of the photos that were used in this manual are of mounts from earlier production runs. You may therefore see some slight differences whether you have a brand new mount or an earlier mount, but none of these were deemed to be of significance.

As always, we highly recommend the Technical Support Section of our website for the latest information and for future, updated versions of this manual. Older versions are also available there.

*PLEASE RECORD THE FOLLOWING INFORMATION FOR FUTURE REFERENCE*

*Mount Serial Number:* \_\_\_\_\_

*Keypad Serial Number:* \_\_\_\_\_

*GTOCP3 Serial Number:* \_\_\_\_\_

*Purchase Date:* \_\_\_\_\_

# MODEL 1200GTO PARTS LIST – MODEL GTOCP3

- 1 Polar axis assembly (right ascension-R.A.) with Servo Box GTOCP3
- 1 Declination (Dec.) axis assembly
- 1 19.5" (18.5" usable) Stainless counterweight shaft (1.875" dia.) with machined, black-anodized, safety stop
- 1 Y cable – R.A. portion is 15.25" long and Dec portion is 40.25" long
- 1 D.C. power cord (cigarette lighter adapter on one end) – 8 feet long
- 1 Straight – through Serial Cable – 15 feet long
- 1 GTO Keypad controller with 15' coiled cable, Instruction Manual and installed Keypad Protector (KEYPRO)
- 1 Hex key set
- 2 8-32 thumbscrews (substitute these for 8-32 set screws that hold GTO Servo Control Box in place, if you wish)
- 1 *PEMPro*™ v.2.x (latest FULL version) Periodic Error Management software (CD-ROM)
- 1 *PulseGuide*™ by Sirius Imaging – remote control utility for improved guiding (CD-ROM)

In order to fully assemble your mount, you will need some of the following items sold separately:

- **Telescope mounting plate:** Many choices to fit your telescope and observing needs.
- **22° to 69° latitude:** Choose either the Standard Pier Adapter (1200SPA) or the Precision-Adjust Rotating Pier Adapter with Azimuth Bearing (1200RPA). Either adapter will come with six 5/16 – 18 X 5/8" button head screws for attachment to the pier, four pier knobs for attaching the mount to the adapter, and the azimuth block for use with the Heavy Duty Azimuth Adjuster found on all 1200GTO mounts produced after August, 2005 and available as an upgrade for earlier mounts.
- **Tropical or extreme polar latitudes (0° to 22° or 69° to the pole North or South):** Choose the Hi-Lo Latitude Wedge Pier Adapter Assembly (1200WDGA) or the Wedge alone (1200WDG) with Flat Surface Adapter (1200FSA) and Rotating Pier Adapter (1200RPA)
- **10" O.D. pier:** Astro-Physics has several heights and styles to choose from.
- **Counterweights:** 5 lb. (5SCWT), 10 lb. (10SCWT) and 18 lb. (18SCWT) are available.
- **Portable rechargeable 12 volt battery pack:** Several sizes and types are available from a variety of vendors. Be sure that your battery pack can supply adequate power for an entire observing session! Please refer to power requirements under Features and Specifications on next page. We recommend having separate batteries – one for the mount – one for all other accessories: camera, dew removers etc.
- **Regulated Power Supply (110V AC to 12V DC converter):** We offer two choices: 13.8 volt 5 amp supply (PS138V5A) or 15 volt, 10 amp supply (PS15V10A). Both supplies are filtered and regulated.

Many of these items will be discussed throughout these instructions. Several additional options are available:

- **9" counterweight shaft extension (M12675):** For heavier loads.
- **Autoguiding Accessories:** Various guiding configurations can take advantage of the 1200GTO's autoguider port. The autoguider port receptacle (RJ-11-6) uses the industry standard SBIG ST-4 wiring setup.
- **Pier accessory trays and support bars:** Accessory Tray (TRAY10) and/or Eyepiece Accessory Trays (TRAY10H) with Bi-Level (TRAYSB) or Single Level (TRAYSB1) Support Bars. Keep things close at hand
- **1200 Flat Surface Adapter (1200FSA):** For attaching one of our pier adapters to your own custom pier or tripod.
- **Polar Alignment Scope:** (PASILL4L – Prior versions sold by Astro-Physics will also work.) Threads into the base of the polar axis assembly. Many users find a polar alignment scope useful for zeroing in on the pole quickly, particularly with telescopes that are not orthogonal to the mount.
- **Extension cable for keypad:** Please call Astro-Physics to obtain a quote on the length of extension cable you need.

Note on Encoders: Mounted shaft encoders can no longer be used with the 1200GTO (for mounts shipped starting in May, 2006 – beginning serial number 1200572) because of the counterweight shaft re-design. They are not needed since the go-to functions of the mount are so much more accurate. The encoder that is built into the servo motor itself has a resolution of 0.05 arc seconds vs. 324 arc seconds for mounted encoders.

# FEATURES AND SPECIFICATIONS

- R.A. worm wheel: 10.3", 225-tooth aluminum  
Dec worm wheel: 7.2", 225-tooth aluminum  
Worm gear: Brass  
R.A. shaft: 3.35" diameter  
R.A. thrust bearings: 9.5" diameter  
Dec shaft: 2.36" diameter  
Dec thrust bearings: 6.5" diameter  
Counterweight shaft: 19.5" overall, 18.5" useable length, 1.875" diameter, stainless steel, removable with Safety Stop  
Latitude range: 22 - 69 degrees with or without polar scope attached (0 - 90 degrees with optional Wedge)  
Azimuth adjustment: Approximately 14 degrees  
Setting circles: Porter Slip Ring design, engraved  
Right ascension: 4-minute increments, pointer  
Declination: 1-degree increments, pointer  
Motors: Zero-cogging servo motors  
Power Consumption: 0.4 amps at the sidereal rate  
3 amps both motors slewing  
Power requirements: 12 VDC, range 11.5 to 16V (higher than 12V recommended for very cold temps and heavy loads, but DO NOT exceed 18V.)  
Weight of mount: Equatorial head: 81 lbs. (36.7 kg)  
Dec axis: 31 lbs. (14.1 kg)  
R.A axis: 50 lbs. (22.7 kg)  
Counterweight shaft: 14 lbs. (6.4 kg)  
Capacity of mount: Approximately 140 lb. (63.6kg) scope and accessories (not including counterweights), depending on length. Will accommodate Astro-Physics and similar refractors up to 206mm f8, 16" Cassegrains and Ritchey-Chretien. These are only guidelines. Some telescopes are very long for their weight or heavy for their size and will require a larger mount.



# INTRODUCTION

The 1200 German equatorial was designed to meet the needs of the advanced observer who requires a mount with maximum strength and rigidity and minimum weight. The excess material in both axes has been carved out while retaining a heavily ribbed structure for internal strength and rigidity. A unique dovetail was machined into the mating surfaces of the R.A. and Dec axes. This feature allows quick and easy assembly in the field without any tools.

The DC servo motor drive with GTO computer system, the keypad with its digital display screen, and the included AP V2 ASCOM Driver, PulseGuide™ and PEMPro™ v.2.x software all combine to offer extraordinary sophistication for today's observer. Whether you enjoy visual astronomy exclusively or plan an aggressive astrophotography or CCD imaging program, this mount will allow you to maximize your night out under the stars.

The advanced keypad features allow you to slew automatically to objects in a wide range of databases as well as any R.A./Dec coordinate. A large selection of common names for stars and other objects makes your selection a snap. The rapid slew rate of 5 degrees per second (1200x) allows you to locate objects very quickly and accurately. You will be very pleased with the intuitive operation of this keypad. There are no complicated sequences of keystrokes to remember. It is so easy to use that even if you don't use it for a few months, you will feel at home with the keypad very quickly.

PulseGuide™ is a stand-alone Windows (98, ME, 2000, NT4, XP, Vista, Win 7) utility that provides complete remote control of all Astro-Physics GTO mounts. It derives its name from its most distinctive feature, pulse guiding, which can improve unguided tracking. Specifically, it can help correct tracking errors caused by polar misalignment and atmospheric refraction. You can also train PulseGuide™ to track objects moving relative to the stars, such as asteroids, comets, and the moon. In addition to pulse guiding, PulseGuide™ also has many useful utility features. PulseGuide™ was written by Ray Gralak of Sirius-Imaging. Please refer to his website <http://www.pulseguide.com> for further developments and enhancements.

PEMPro™ (Periodic Error Management Professional) is a Windows software application that makes it easy to characterize and reduce periodic error. PEMPro™ will analyze the performance of any mount that is equipped with a CCD camera and compatible camera control software. PEMPro™ gives you powerful tools to program your mount's periodic error correction firmware to achieve the best possible performance for your mount. PEMPro™ dramatically improves guided and unguided imaging resulting in better images and fewer lost exposures. PEMPro™ v.2.x Full Version also adds a Polar Alignment Wizard and a video interface for using many webcams. PEMPro™ v. 2.x Full Version began shipping with 900GTO mounts in May, 2008 and continues now with the 1200GTO and 3600GTO's.

The periodic error of your 1200GTO will be 5 arc seconds or less (before correction). We have already loaded the PEMPro curve that was generated during your mount's testing into the servo to reduce the error even further, and to give you a head start right out of the box. See additional information under "Servo Motor Drive."

The 1200 is equally at home in a permanent observatory or as a portable mounting for remote star parties thanks to the ease with which the two axes come apart. This is the perfect mount for a large refractor, Newtonian, Cassegrain or astrograph.

In order to maximize your pleasure on your first night out, we recommend that you familiarize yourself with the assembly and basic operation of the mount indoors. The temperature will be comfortable, the mosquitoes at bay, and you'll have enough light to see the illustrations and read the manual. Please take particular note of counterbalancing, use of the clutches and operation of the keypad controller.

## Why Polar Alignment is Important

Polar alignment compensates for the Earth's rotation.

If you were to take a long exposure photograph with Polaris (often called the north star) in the center of the field, you would discover that all stars seem to revolve around Polaris. This effect is due to the rotation of the earth on its axis. Motor-driven equatorial mounts were designed to compensate for the earth's rotation by moving the telescope at the same rate and opposite to the earth's rotation. When the polar axis of the telescope is pointed at the celestial pole (polar aligned) as shown in the diagram at right, the mount will follow (track) the motions of the sun, moon, planets and stars. As a result, the object that you are observing will appear motionless as you observe through the eyepiece or take astrophotos.

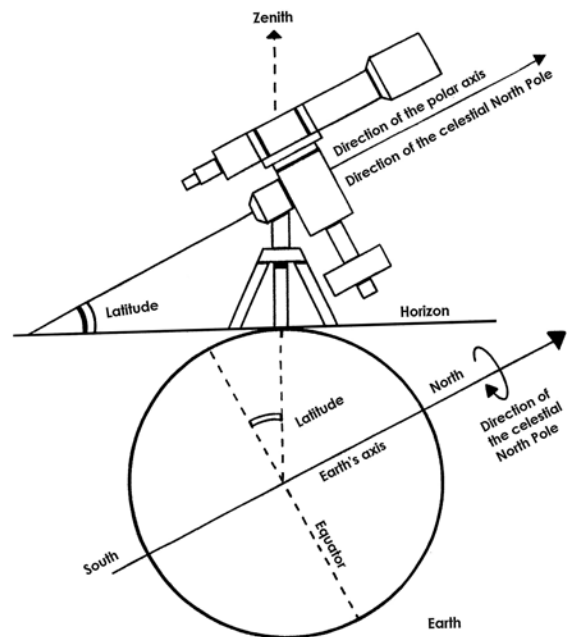

# ASSEMBLY DIAGRAM

Please read all instructions before attempting to set up your 1200 mount. The Model 1200 is very rugged, however like any precision instrument, it can be damaged by improper use and handling. Please refer to the diagram below for an illustration of the mount. The parts are labeled so that we can establish common terminology.

The following terms and abbreviations are used interchangeably in these instructions:

- polar axis = right ascension axis = R.A. axis = R.A. housing
- declination axis = dec. axis = dec. housing

Your 1200GTO must be used with a pier adapter which includes the azimuth adjuster block, center pivot screw and pier adapter knobs. Please choose one as shown below.

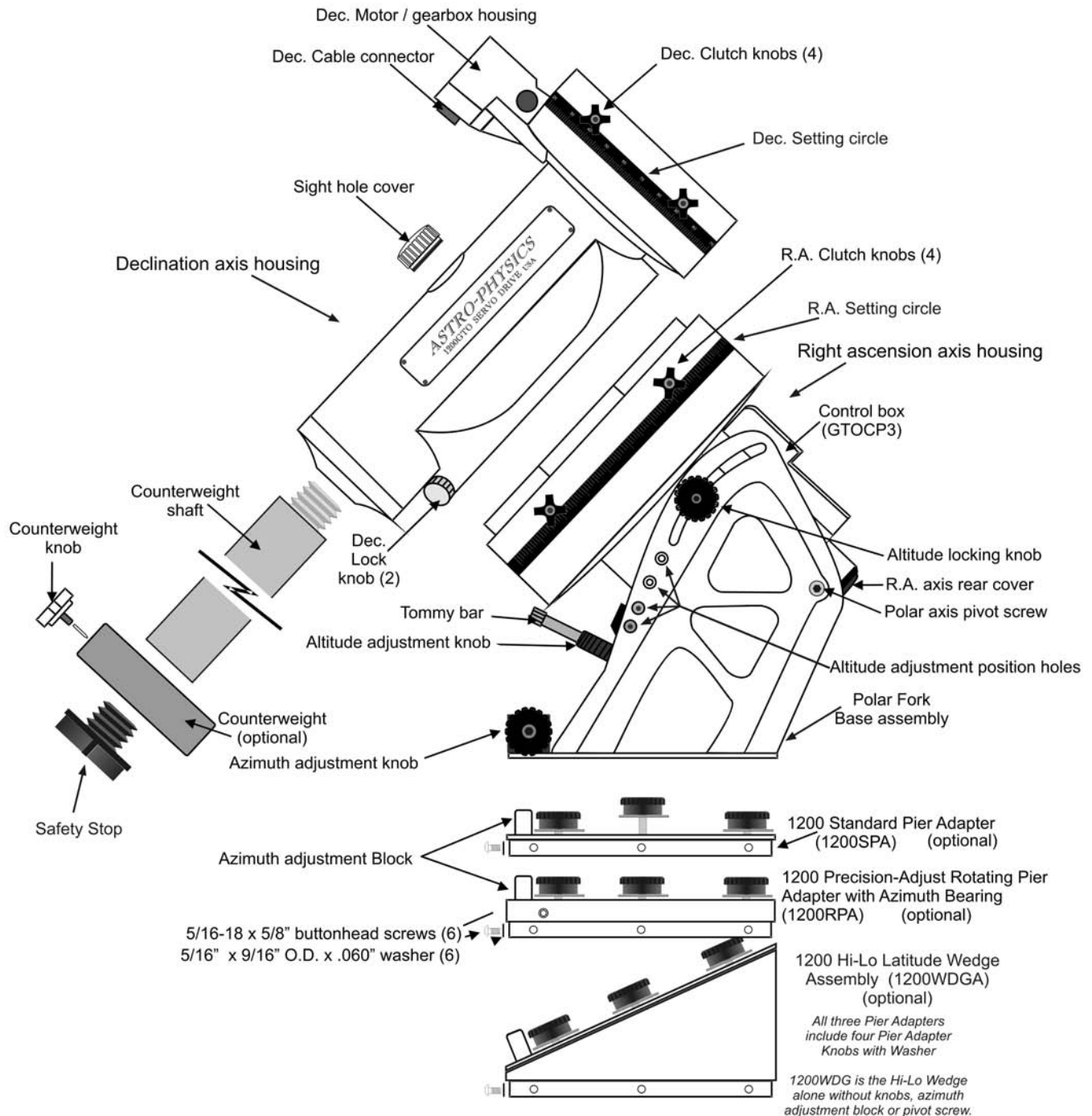



# BEFORE YOU LEAVE HOME

Since most of us must set up our instruments in the dark, in the cold or while battling mosquitoes, a bit of pre-planning and organization is important. There are few simple things that can be accomplished in the comfort of your home before heading outside.

## Gross Latitude Adjustment for 1200GTO German Equatorial Mounts

**Mounts shipped starting in May, 2006. Beginning with Serial Number 1200572. Older mounts will have slightly different latitude ranges unless they were upgraded with the taller polar fork.**

The latitude range of the 1200 mount is approximately 22 - 69 degrees with considerable overlap at each position. Since most astronomers typically observe within one latitude range, this adjustment is made just once, if at all. Prior to shipment, we preset the mount to your latitude range for your convenience. We suggest that before you travel to an observing location, determine the approximate latitude of your observing site and make the appropriate rough adjustment. If you live in or plan to travel to locations that are 0-22 degrees latitude, we recommend our Hi-Lo Latitude Wedge Assembly (1200WDGA).

The four positions for the altitude adjustments have the following approximate ranges:

- 57.5° to 69° latitude - top position (1)
- 41° to 63° latitude - second position (2)
- 30° to 48.5° latitude - third position (3)
- 22° to 38° latitude - bottom position (4)

### How to change the position of the altitude adjuster

1. Use only the R.A. axis. DO NOT attempt to make these adjustments with the declination axis in place and certainly not with an instrument fully mounted.

2. Loosen both altitude-locking knobs about 1 turn.

3. Locate the side of the polar axis that does not have the motor / gearbox housing. Loosen (about 1 turn) the polar axis pivot screw and altitude adjuster bar fixing screws on this side only. With your hand, push the polar axis upwards so that the altitude-locking knobs are positioned at the top of the altitude slot (this is the maximum altitude position). Some resistance will be felt with this operation as you are pushing against the weight of the polar housing and the resistance of the remaining polar axis pivot screw (which has not been loosened).

4. Before attempting to remove or move the altitude adjuster bar, you must tighten the altitude-locking knob on the motor / gearbox housing side. This will prevent any downward movement of the polar axis during positioning of the altitude adjuster bar.

5. While supporting the altitude adjuster bar, remove the two screws that support it on each side (4 screws in all). Keep the two ends of the bar in contact with the side of the mount, don't remove the bar completely (this tip is for your convenience).

6. Determine the latitude range that you need and position the altitude adjuster bar so that the hole that is marked "A", as shown in the diagram, is located at the appropriate hole position numbered 1-4 in the diagrams (above and next page). Note that hole "A" is located at the rounded part in the center of the altitude bar. Hole "A" is the "latitude hole."

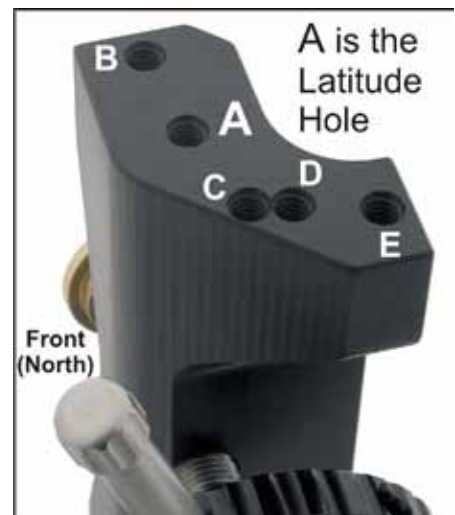
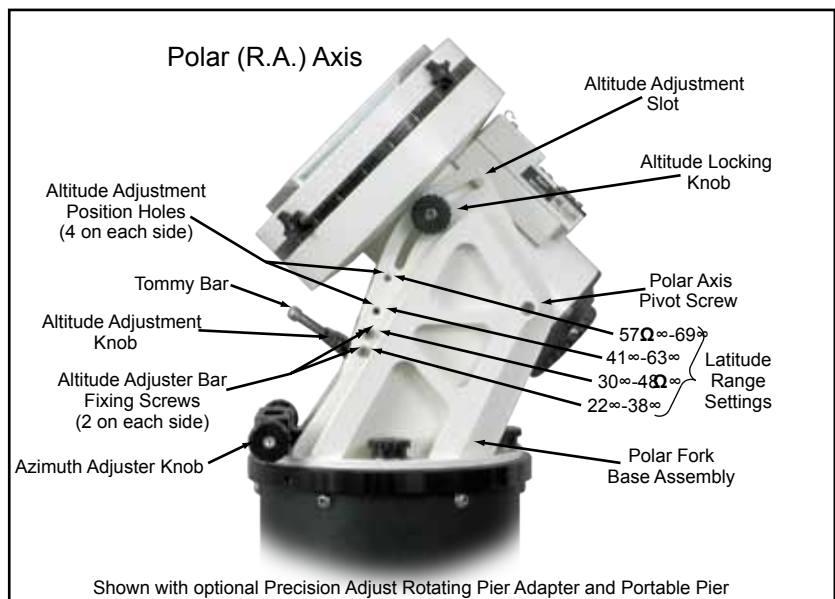

- Attach two of the screws (one on either side of the adjuster bar) through the appropriate altitude adjustment position hole and into hole A of the adjuster bar, but do not tighten. Rotate the altitude adjuster bar around this pivot point until the corresponding hole lines up. Consult the diagram to determine which hole of the altitude adjuster bar should be used. Be very careful since the holes marked C and D are very close to one another. The incorrect hole may appear to line up, however it will be slightly off. If you try to attach at the incorrect hole, you may strip the threads of the altitude bar. The correct hole will orient the adjuster to be roughly perpendicular to the axis once the axis is lowered into place.

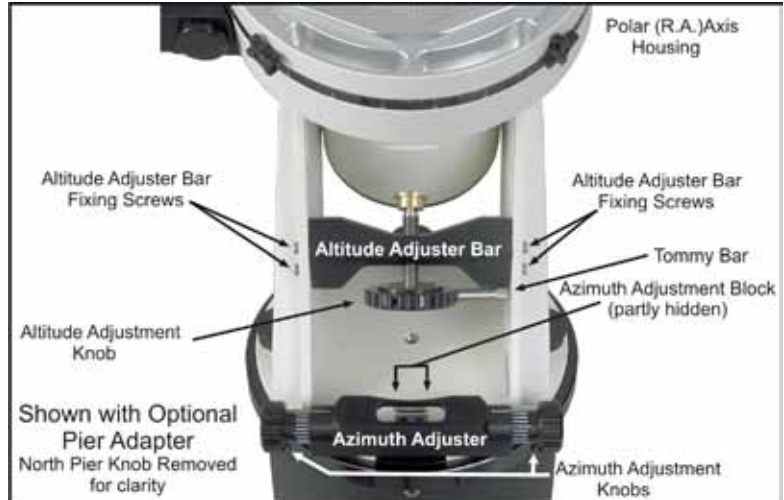

- Once you have located the correct hole, insert the remaining two screws, and lightly tighten so that you still have some ability to wiggle the bar.
- Note that the altitude adjustment knob is attached to a threaded rod that travels through the altitude adjuster bar. Turn the knob so that the altitude adjuster bar is positioned approximately in the middle of the threaded rod. You should see about half of the threaded rod protruding from both sides of the altitude adjuster bar. This will allow you to move the mount fully within the altitude range.
- At the end of the threaded rod mentioned in the last step, you will see a small brass altitude adjuster thrust pad. This is the part that will come in contact with the polar axis as you ease it back into position. Loosen the altitude-locking knob (motor/gear side) and lower the polar axis so that it rests comfortably on this pad. The threaded rod should be positioned at roughly a right angle to the polar axis housing. Firmly tighten the altitude adjuster bar fixing screws.
- Turn the altitude adjustment knob to raise or lower the polar axis to your approximate observing latitude. Tighten the altitude locking knobs with finger pressure only. You do not need to tighten with the hex key.
- Firmly tighten both polar axis pivot screws with the hex key.

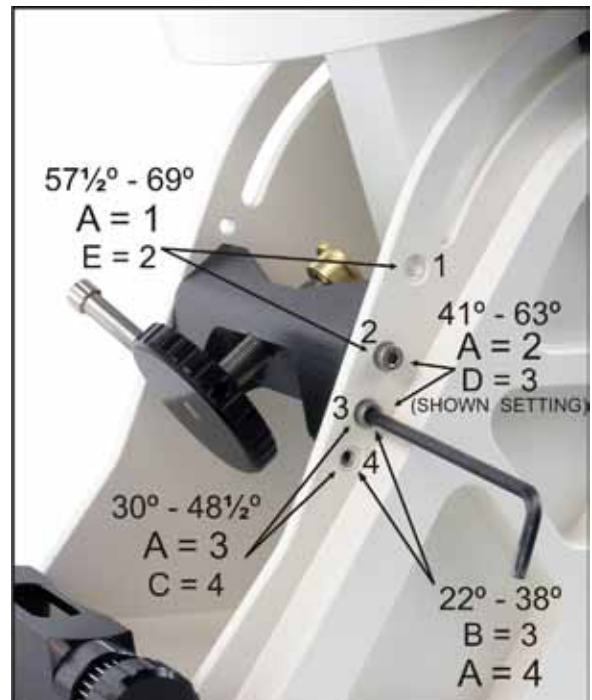

## Attach Pier Adapter to Pier Post (purchased separately)

If you purchased the pier from Astro-Physics, the pier adapter of the 1200 will attach right to the top of the pier. If you are constructing your own pier or tripod, you will need to incorporate this part. Three models of the pier adapter are now available for use with the 1200 from Astro-Physics. The Standard Pier Adapter (1200SPA) and the Precision Adjust Rotating Pier Adapter (1200RPA) are the choices for people living within the mount's 22 to 69 degree latitude range. For customers in tropical or extreme polar latitudes, the third adapter: the Hi-Lo Latitude Wedge is also available as either a complete assembly (1200WDGA) or as the Wedge alone (1200WDG). If you have more than one pier, you may wish to purchase two adapters so that you can leave them attached permanently. You will probably want to attach the pier adapter to the pier post before going to your observing site. We recommend that you leave whichever pier adapter you choose attached to your pier post for transport and storage. These pier adapters can be used with all prior versions of the 1200 mount.

If you did not purchase one of our pier adapters described below - for instance, if you purchased the Monolith Pier from Particle Wave Technologies, you will need to purchase the Pier Adapter Knob Kit (part# 12KBKIT) in order to attach your mount to the Monolith.

### Important notes for all three pier adapters or when using the Monolith Pier :

- The washers for the pier adapter knobs must be positioned with the smooth surface and rounded edge down so that the assembly can be adjusted back and forth. (Not important for the Precision-Adjust Rotating Pier Adapter.)
- Do NOT remove the center pivot screw. Just as the name implies, this is the point around which the mount rotates (pivots) when making azimuth adjustments. The screw head has been machined to assure a close fit. Please do not replace it with another screw.

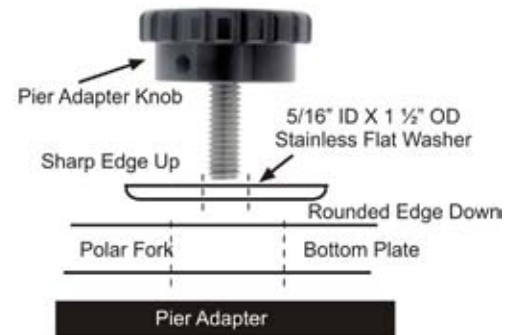

## Standard Pier Adapter (1200SPA)

This 1200 Pier Adapter is similar to those that we have included with mounts in the past, however the azimuth adjuster block is slightly taller to accommodate the improved azimuth adjuster assembly on all 1200GTO mounts produced after January, 2004 (and all upgraded older mounts). If you have a permanent installation, this base is a good choice since you will not have to set up every session.

The adapter includes the machined flat plate, four machined aluminum lock knobs with 5/16 " ID x 1.5" OD stainless washers, the azimuth adjuster block, center pivot screw and six 5/16-18 x 5/8 button head screws and washers. All machined parts are black anodized. The Standard Pier Adapter was designed to fit into a 10" x 0.094" wall tube.

*Attach to an Astro-Physics pier:* To attach the pier adapter to your Astro-Physics pier, simply set the adapter into the top of the pier post, make sure the azimuth adjuster block is on the north side, and fasten from the side with the six screws and washers provided.

*Attach to a flat surface on your own pier:* If you are mounting to a flat surface of your own design, simply use four 1/4-20 stainless steel cap screws of appropriate length, fastened through the top of your adapter. Refer to the diagram in the back of the manual for bolt pattern information.

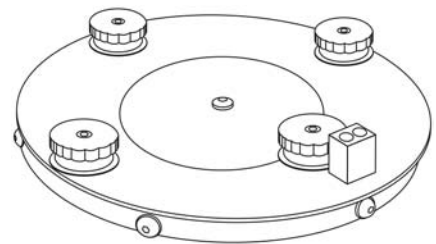

If you prefer a more finished look, you may wish to consider using our 1200 Flat Surface Adapter (1200FSA). The Flat Surface Adapter bolts onto the flat plate on top of your pier or tripod, then the Standard Pier Adapter slips in (just as it fits into our pier) and you fasten from the side with the six screws and washers provided with the Standard Pier Adapter. The bolt circle for attaching the 1200 Flat Surface Adapter to your pier is 9.230" diameter.

*Using an ATS pier:* The O.D. of the plate will need to be modified by ATS for an additional charge.

## Precision-Adjust Rotating Pier Adapter with Azimuth Bearing (1200RPA)

This pier adapter was designed for very accurate and smooth adjustment of the azimuth angle without loosening the lock-down knobs on the base of the mount. The top plate of the adapter rotates through the 1200GTO mount's full 14 degrees of azimuth motion. (It does **not** rotate through a full 360 degrees!) This Precision-Adjust Rotating Pier Adapter is the ideal choice for portable setups as it makes azimuth adjustment so easy. Upgrade your previous model 1200 mount (any version) and enjoy the ease of use. Do a setup, followed by a fine polar alignment at a remote site just once, and you will wonder how you ever got along without this pier adapter!

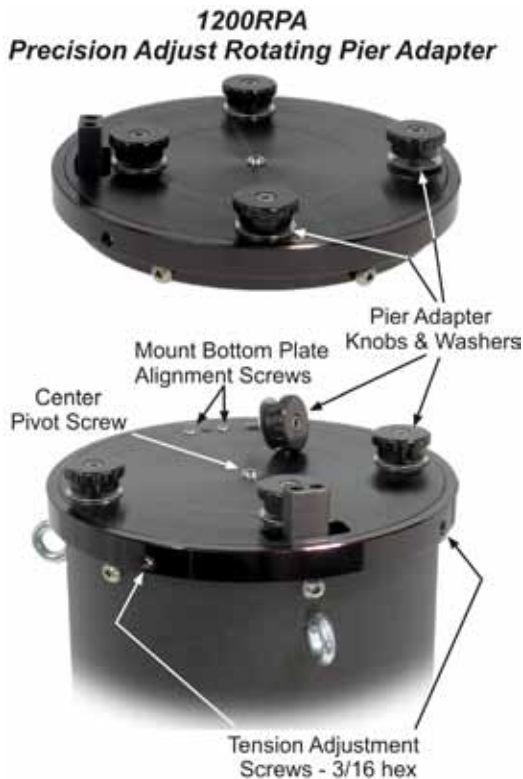

The adapter includes the Rotating Pier Adapter assembly, four machined aluminum lock knobs with 5/16" ID x 1.5" OD stainless washers, a tall version of the azimuth adjuster block, center pivot screw and six 5/16-18 x 5/8 button head screws and washers.

*Attach to an Astro-Physics pier:* Simply fit the Precision-Adjust Rotating Pier Adapter into your Astro-Physics Portable Pier just like the Standard Pier Adapter and fasten it from the side with the six screws and washers provided. Again, make sure that the Azimuth Adjuster Block is on the north side.

*Attach to a flat surface on your own pier:* The Precision-Adjust Rotating Pier Adapter must fit inside another part and be bolted from the side. It cannot be bolted through the top as you can with the Standard Pier Adapter. We recommend our 1200 Flat Surface Adapter (1200FSA). The Flat Surface Adapter bolts onto the flat plate on top of your pier or tripod, then the Precision-Adjust Rotating Pier Adapter slips in (just as it fits into our pier) and you fasten from the side with the six screws and washers provided with the Precision-Adjust Rotating Pier Adapter. The bolt circle for attaching the 1200 Flat Surface Adapter to your pier is 9.230" diameter.

*Using an ATS pier:* If you plan to use an ATS pier, the O.D. of the plate will need to be modified by ATS for an additional charge.

The two recessed screws (3/16 hex), shown by the arrows, adjust the tension between the two plates of the Precision-Adjust Rotating Pier Adapter. These are preset to an optimal tension and should rarely, if ever, need to be re-adjusted. You **do not** need to tighten or loosen these two screws as part of your normal polar alignment routine. For more detailed

information regarding this adapter plate, please review the Adobe Acrobat document entitled "Precision-Adjust Rotating Pier Adapter(1200RPA) – Information and Instructions" on the Technical Support page of our website.

## Hi-Lo Latitude Wedge Pier Adapter Assembly (1200WDGA) or Wedge Alone (1200WDG)

### for 0°-22° or 69°-90° Latitude – North or South

If your latitude is between 22° north and 22° south or above 69°, either north or south, this wedge assembly includes everything you need to place your 1200 mount in the proper position.

The 1200 Wedge Assembly includes the machined wedge and flat plate, the 1.2" Azimuth Adjuster Block, four Pier Adapter Knobs with 5/16" ID x 1 1/2" OD flat washers, the center pivot screw, six 5/16-18 x 5/8 socket button head screws and six 5/16 x 9/16"OD x 0.060" flat washers, which enable you to attach the pier adapter to your Astro-Physics pier.

NOTE: The photo shows the Hi-Lo Latitude Wedge ready to be used at tropical latitudes with the Azimuth Adjuster Block on the low side. For extreme polar latitudes, the Azimuth Adjuster Block can simply be moved to the high side of the wedge to extend the useful range of your 1200GTO above 69° latitude. All required tapped mounting holes are provided.

*Attach to an Astro-Physics pier:* To attach the Hi-Lo Latitude Wedge to your Astro-Physics pier, simply set the adapter into the top of the pier post, make sure the azimuth adjuster block is on the pole side, and fasten from the side with the six screws and washers provided.

*Attach to a flat surface on your own pier:* The Hi-Lo Latitude Wedge must fit inside another part and be bolted from the side. It cannot be bolted through the top as you can with the Standard Pier Adapter. For custom installations, we recommend our 1200 Flat Surface Adapter (1200FSA). The Flat Surface Adapter bolts onto the flat plate on top of your pier or tripod, then the Hi-Lo Latitude Wedge Pier Adapter slips in (just as it fits into our pier) and you fasten from the side with the six screws and washers provided. The bolt circle for attaching the 1200 Flat Surface Adapter to your pier is 9.230" diameter.

*Using an ATS pier:* The O.D. of the plate will need to be modified by ATS for an additional charge.



*More Options:* If you already own a 1200 Standard Pier Adapter, or if you would like to construct a "Precision Adjust Rotating Wedge," you can simply order the 1200 Wedge by itself (1200WDG). It will come with the six 5/16-18 x 5/8 socket button head screws and six 5/16 x 9/16"OD x 0.060" flat washers, but no knobs, pivot screw or azimuth block. To use the wedge in place of a Standard Pier Adapter, simply transfer the knobs, Azimuth Adjuster Block and Center Pivot Screw to the Wedge.



To create the "Rotating Wedge," mount a 1200 Flat Surface Adapter (1200FSA) onto the top of the wedge using the holes provided, and then insert a Precision Adjust Rotating Pier Adapter (1200RPA).

# AT YOUR OBSERVING SITE

## Assemble Pier (purchased separately)

Begin by assembling the portable pier at the desired observing location. Take note which direction is north.

1. Slide the three legs onto the nubs of the base and rotate the assembly so that one of the legs points toward north (or south, if that is your preference).
2. Place the pier post on the base orienting the center azimuth block directly north. If you choose to have one leg north, then the pier adapter plate will have to be installed with the azimuth block directly over a turnbuckle. If you have one leg south, the pier adapter plate will have to be installed with the azimuth block over and between two of the pier post turnbuckles.
3. Attach the tension rods. The turnbuckles should be drawn tight until the whole assembly is stiff enough to support your weight without movement.

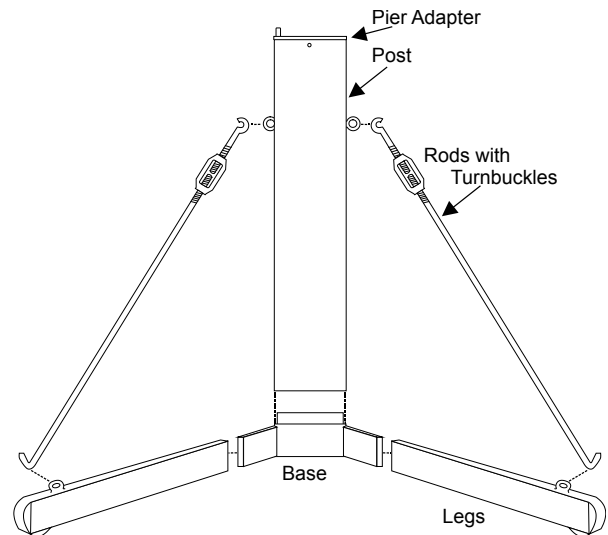

## Assemble Polar Axis Assembly to Pier or Tripod

In order to track the motion of astronomical objects, the polar axis must be positioned so that an imaginary line drawn through the center of the axis points toward the celestial pole. Refer to the diagram at the front of this manual for a graphical representation. At this stage of the assembly process, you want to position the mount so that it points roughly north.

1. Remove the four (4) pier adapter knobs from the Pier Adapter and keep them close at hand.
2. Prior to lifting the polar axis assembly into place, turn the fine azimuth adjustment knobs so that the space between them is wide enough to allow the pier adapter's azimuth block to fit easily between them. Ensure both pier top and polar axis assembly mating surfaces are clean and free of dirt. If you are using the Precision-Adjust Rotating Pier Adapter, make sure that the Altitude Adjuster Block is centered in the slot of the top plate.
3. Place the polar axis assembly onto the pier top adapter so that the center azimuth block fits between the fine azimuth adjustment knobs. The Center Pivot Screw on the Pier Adapter (all models) will help you center the mount on the adapter.
4. Move the base of the polar axis assembly so that the threaded holes of the pier top can be seen through each of the four slots.
5. Thread the four hand-knobs loosely in place (you will tighten these later after polar alignment) with the washers underneath. If you are using the Standard Pier Adapter, be sure that the side with the rounded edge is facing down. This will ensure smooth movements as you adjust your polar alignment. The position of the washers does not matter for the Precision-Adjust Rotating Pier Adapter.



## Polar Alignment – Part 1 – Rough Alignment

We recommend that you accomplish your polar alignment in two phases – rough alignment and fine alignment. Fine alignment will be discussed in a later section of this manual.

### Altitude and Azimuth Adjustments - Rough polar alignment

For rough polar alignment, your goal is to sight the celestial pole when looking through the polar alignment sight hole in the center of the polar axis. You will need to make altitude (up/down) and azimuth (side-to-side) adjustments to the position of the mount.

We recommend that you do your rough polar alignment with the R.A. axis only since you will be making major adjustments to the position of the mount at this time. The remainder of the mount, telescope and counterweights will add considerable weight and require more hand effort. Later, you will do your final polar alignment with the telescope and counterweights attached, but the adjustments will be small. An inclinometer and a compass adjusted for magnetic declination at your location can be very helpful for daytime setup. In addition, be sure to learn the Daytime Polar Alignment Routine as described in the keypad manual. It is a great method for rough alignment!

1. If the Polar Scope (PASILL4L) is installed, you may remove it to complete these steps. Alternatively, you can simply sight up the side of the polar axis to see Polaris.
2. If you examine the polar axis assembly, you will see that the center of the R.A. shaft is hollow. If you have the Standard Pier Adapter or the Hi-Lo Latitude Wedge Pier Adapter and have not done so already, slightly loosen (1/2 turn) the four pier knobs. If you have the Precision-Adjust Rotating Pier Adapter you do NOT loosen the Pier Knobs.

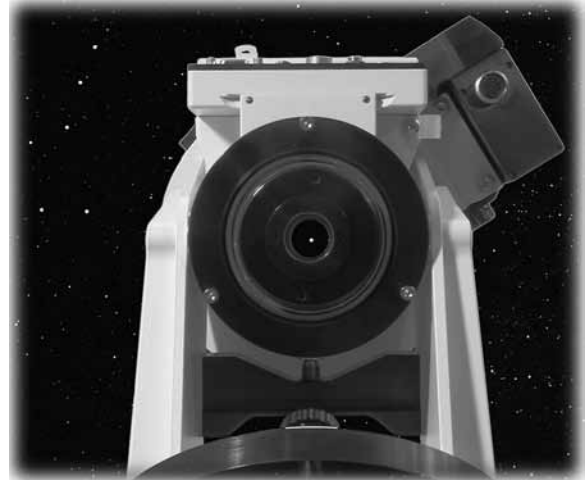

**Sighting Polaris through  
Polar Alignment Sight Hole**  
Mount shown is a 900GTO

NOTE: If you have already attached the Dec. axis, remove the sight hole cover and rotate the internal Dec. shaft by moving the top of the Dec. axis (or the cradle plate if it is attached) to reveal the sight-hole that has been drilled into it. Now, you can look through the shaft to the other side.

3. **Azimuth adjustments:** To begin with, move or turn the entire pier or tripod east or west until the mount is oriented approximately towards the pole (an imaginary line drawn through the hollow shaft). Use the two fine azimuth adjustment knobs, one on each side of the mount, to make adjustments. You must back off the opposing azimuth knob in order to move the other knob in that direction. Please refer to the photos below. These photos also illustrate the 14 degrees of azimuth adjustment possible with this mount.

**One full turn of the azimuth knob is approximately 0.53 degrees (31.8 arc minutes). Small graduations are 1.06 arc minutes; long graduations are 5.3 arc minutes.**

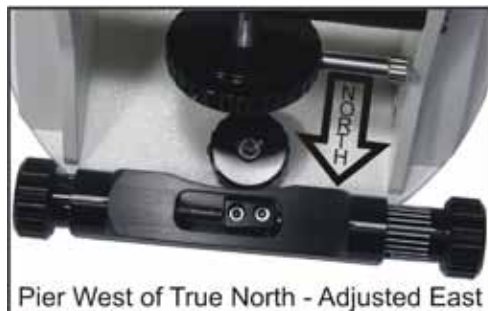

The best adjustment technique to use with the Astro-Physics Heavy Duty Azimuth Adjuster, with its clear registration marks for fine adjustment, is to back off one of the knobs by a set amount (a certain number of registration marks) and then to turn the other knob until you re-establish contact on both sides of the Azimuth Adjuster Block. You can very precisely zero in on the desired position with no backlash or ambiguity on the position. You can also always go back to the precise starting point if for some reason you overshot your mark (or if you adjusted the wrong way), because you know exactly how far you've gone. This is explained further in the section on Fine Polar Alignment.

4. **Altitude (latitude) adjustments:** Loosen the altitude locking knobs. Move the polar axis up or down with the large altitude adjustment knob located in the front of the polar axis assembly. The tommy bar can be positioned in any of the threaded holes located in the altitude adjustment knob. Use this bar to help you turn the knob. We have found that using the turnbuckle on the north leg of our pier also can make fine altitude adjustments, if used.  
**One turn of the altitude knob is approximately 0.5 degrees (30 arc minutes).**
5. Continue your azimuth and altitude adjustments until you can sight Polaris in the polar alignment sight hole. At this point, you have achieved a rough polar alignment, which may be sufficient for casual visual observations, if you are not planning to slew to target objects with the keypad. When the R.A. motor is engaged (the power is plugged in), it will compensate for the rotation of the earth and keep the target object within the eyepiece field of view. Your target object will slowly drift since polar alignment at this stage is only approximate. However, you can make corrections with the N-S-E-W buttons of your keypad controller.
6. Tighten the altitude locking knobs by hand.
7. If you are using the Standard Pier Adapter or the Hi-Lo Latitude Wedge, tighten the pier knobs firmly by hand. On the Precision-Adjust Rotating Pier Adapter, the knobs will already be tight.

## Assemble Declination Axis

1. Do not have your telescope or counterweights connected to the Dec. axis assembly for either assembly or disassembly of the Dec. and RA axes.
2. Position the R.A. axis as shown in the illustration at right with the single pocket "A" at the top, opposite the altitude adjuster knob. Firmly tighten R.A. clutch knobs.
3. During shipment, the Dec. axis assembly lock knobs will be fully screwed into the Dec. axis. For correct assembly, these lock knobs should be unscrewed at least 7 full turns and no more than 8.5 full turns. This is between 5/16" and 3/8" out from the "shipped" tightened position. NOTE: These lock knobs can be completely removed from the Dec. axis assembly with about 9.5 full turns out.
4. Position the Dec. axis above the R.A. axis as shown in the lower illustration at right, a light movement (wiggle) in the downward direction (arrow "A") will help to correctly seat the principle dovetail(s) and parallel guides.
5. When both Dec. and R.A. assemblies are fully seated, hand tighten both Dec. lock knobs.
6. Thread the counterweight shaft into the Dec. axis.
7. Remove the Safety Stop from the base of the counterweight shaft. Add sufficient counterweights (5, 10 or 18 lb. counterweights are purchased separately) to the declination shaft to balance the telescope you intend to use. Always use two hands to attach or move them on the shaft.
8. Reattach the Safety Stop to the end of the declination shaft. This will help to prevent injury if someone accidentally loosens the counterweight knob.

NOTE: Firm tightening of the counterweight knob will not damage the surface of the counterweight shaft. The pin that tightens against the stainless counterweight shaft is constructed of brass. Likewise, the bronze sleeve that has been press fit into the center of the counterweight will prevent marring of the shaft as you move the counterweight up and down.

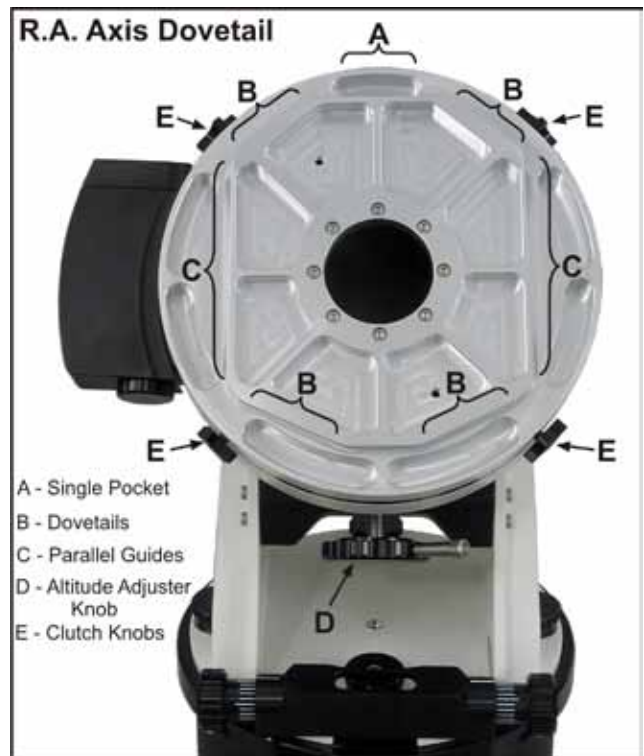



## Removing Declination Axis at the End of Your Observing Session

1. Remove your telescope, counterweights and counterweight shaft.
2. Unscrew the lock knobs 5.5 to 7 full turns (this is still 5/16" to 3/8" out from the fully tightened position) and slide/tilt the Dec. axis assembly in an upwards direction (arrow "B" on previous page).
3. For transport/storage we recommend fully tightening the lock knobs.

## Attach Mounting Plate (purchased separately)

Take note of the hole-patterns available on the declination hub of the 1200GTO. Most of you will use either the outer six-hole bolt pattern or else the inner four-hole bolt pattern to attach your mounting plate. Some of the plates can use bolt holes from both the four and six hole-patterns. Please note that the mounting plates below are drawn at a smaller scale than the hub at right. The plates are relatively at scale with each other for comparison.

Several mounting plates (also called cradle or saddle plates) are available for the 1200 mount. If you own more than one instrument, you may need more than one plate. Follow the appropriate directions for the plate(s) that you have. The darkened holes represent those used for the 1200 mount.

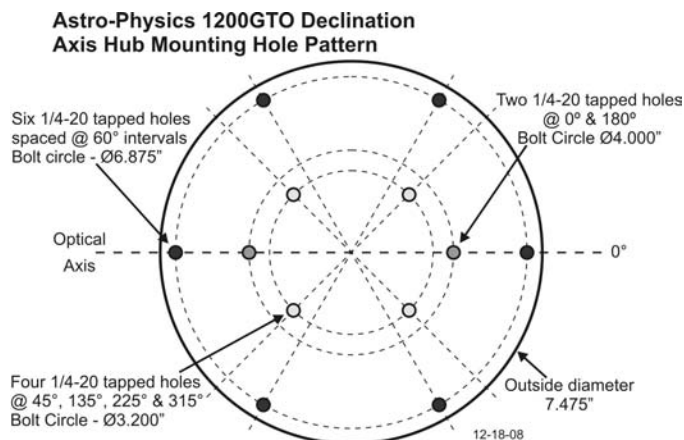

### 18" Flat Mounting Plate (FP1800)

This plate is 18" long and 7.5" at its widest point in the center. The width of the plate tapers to 5.5" at each end. Four pairs of keyhole slots that measure 3.2" between centers are provided. The two inner pairs are 13.75" apart and the outer two pairs are 17" apart. You can drill additional holes to suit your needs. This plate also fits the 900 German Equatorial.

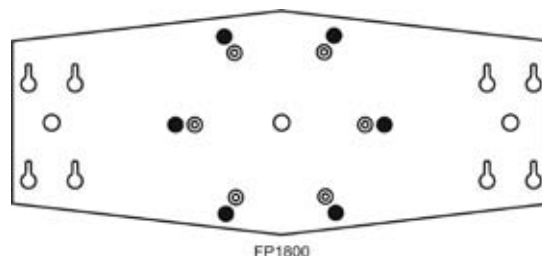

Attach this plate with six 1/4-20 x 1" flat head socket cap screws.

### 15" Ribbed Mounting Plate (1200RP15)

This plate is 14.75" long, 7.75" at its widest point, 5" at each end and 1" thick. The underside of the plate is carved into a ribbed pattern to maximize the strength and minimize the weight - 3 lbs. A pair of keyhole slots that measure 3.2" between centers are provided at each end. The distance between the pairs is 13.75".

Attach this plate with six 1/4-20 x 3/4" socket head cap screws. Note that the plate is asymmetrical. In most cases, orient the plate so that the long end points toward the sky. You can also turn the plate in the other direction to balance your scope.

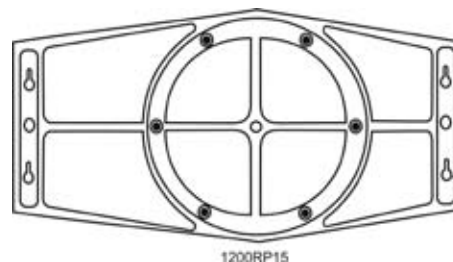

### 24" Ribbed Mounting Plate (1200RP)

For larger instruments, the ribbed structure of this plate provides the maximum support. Our machinist begins with thick aluminum plate and carves a strong rib structure. The final result is 1.5" thick, 24" long and 7.6" at its widest point. The width of the plate tapers to 5.5" at each end. A pair of keyhole slots that measure 3.2" between centers are provided at each end. The distance between these pairs of holes is 23". Due to the ribbed structure, you may not be able to drill additional holes for non-

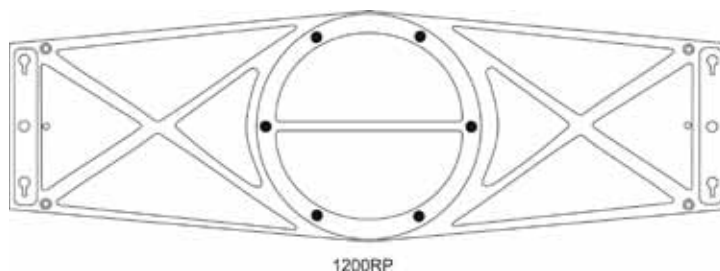

Astro-Physics mounting rings. The plate weighs an amazing 9.5 lbs. for its size. This is a view of the rib structure on the underside of the 24" plate.

Attach this plate with six 1/4-20 x 1" socket head cap screws.

### 8.5" Dovetail Saddle Plate for Losmandy D Series Plates (DOVELM2)

This Astro-Physics plate attaches to the 400, 600E, 900 and 1200 mounts. If you already own one of the Losmandy DAP series (fits Astro-Physics refractors), DC series (for Celestron 8" 9.25" or 11" SCTs) or DM series (for Meade 8" and 10" SCTs) plates, you should consider this plate or the longer ones below. For larger size SCT's we recommend the longer DOVELM162 – see below.

Note that the two bolt-hole patterns are offset from the center. This allows you to position the plate either forward or backward depending on the balance point of your telescope. Attach this plate with four 1/4-20 x 3/4" socket head cap screws and/or two 1/4-20x5/8" flat head socket cap screws.

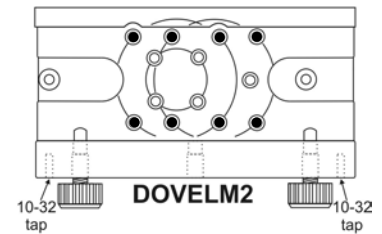

Additional features include a center position knob-hole for use with short D series plates, a ribbed structure underneath to reduce weight and tapped 10-32 holes in the side for cable attachment.

### 16" Dovetail Saddle Plate for 1200 Mounts and Losmandy D Series Plates (DOVELM16)

This Astro-Physics plate is no longer produced and has been replaced by the DOVELM162 below. If you already own one of the these plates, and use a 17.25" or longer Losmandy DAP series (fits 6" and larger Astro-Physics refractors) plate, this mounting plate will work fine. SCTs, RCs and other instruments that are challenging to balance should use the DOVELM162 as shown below.

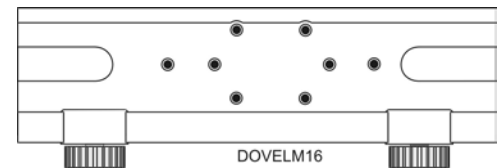

Note that the bolt-hole pattern is offset from the center. This allows you to position the plate either slightly forward or backward depending on the balance point of your telescope. Attach this plate with 1/4-20 x 1" socket head cap screws.

### 16" Easy-Balance Dovetail Saddle Plate for Mach1GTO, 900 and 1200 mounts and Losmandy D Series Plates (DOVELM162)

This Astro-Physics plate was introduced in February, 2009. The DOVELM162 provides a multitude of mount attachment options, and was specifically designed to meet the balancing demands of "back-end-heavy" instruments like SCT's and Richey-Chrétien's, especially those with heavy imaging gear hanging off the back! This plate has small knobs to avoid interference with the declination hub, but the knobs have cap screws in the ends that accept a 3/16 hex wrench for extremely secure clamping of your instrument. Additional features include ribbed structure underneath to reduce weight and tapped 10-32 holes in the side for cable attachment.

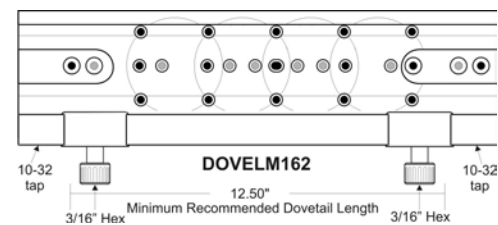

Note that the bolt-hole patterns are marked with scribe cuts. The four-hole patterns can all be supplemented with bolts along the optical axis in the six-hole pattern giving six attachment points at each position. Attach this plate with 1/4-20 x 1" socket head cap screws and possibly one 1/4-20 x 3/4" flat head socket cap screw (if at an end position).

### 15" Astro-Physics Dovetail Saddle Plate (DOVE15) for 15" Sliding Bar (SB1500)

The 15" version of our dovetail plate is suited for the 130 f8 StarFire EDT, 155 f7 StarFire EDFS, ARO Maksutovs, Takahashi scopes and other instruments of similar size. The knob assembly features a brass pin with a tapered end to hold your sliding bar firmly without marring the aluminum. Use with the 15" Sliding Bar (SB1500), which is sold separately (**NOT** for use with Losmandy "D" or "V" plates or Vixen plates). Also makes a great accessory plate when used with either the 1200RP15 or FP1800 (with rings mounted to inside holes)

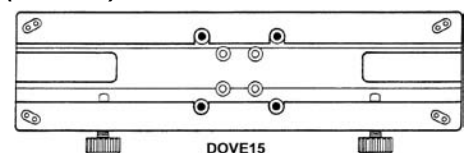

Attach with four 1/4-20 x 5/8 flat head socket cap screws.

## ***Attach Counterweight Shaft and Counterweights***

IMPORTANT:

- Always attach the counterweights before mounting the telescope to the cradle plate to prevent sudden movement of an unbalanced tube assembly, which may cause damage or injury.
  - Remember counterweights are heavy and will hurt if they fall on your foot.
1. Thread counterweight shaft onto the Dec. axis. Be careful not to cross-thread! Do not tighten too much, since you will need to remove it later.
  2. Remove the safety stop (a hand knob and washer were provided on older mounts) from the end of the counterweight shaft. Add sufficient counterweights (5, 10 or 18 lb. counterweights are available) to the shaft to balance the telescope you intend to use. Loosen the counterweight knob and hold the counterweight with the knob pointing downward so that the brass pin will move from the center opening allowing the counterweight to slide into position. Always use two hands to attach or move them on the shaft. It is advisable to have the counterweight knob pointing down toward the pier. This will minimize the chance of accidentally loosening the counterweight during the observing session.
  3. Re-attach the safety stop to the end of the counterweight shaft. This will help to prevent injury if someone accidentally loosens the counterweight knob.

NOTE: A firm tightening of the counterweight knob will not damage the surface of the counterweight shaft. The pin that tightens against the stainless counterweight shaft is constructed of brass. Likewise, the bronze sleeve that has been press fit into the center of the counterweight will prevent marring of the shaft as you move the counterweights up and down.

## ***Attach Mounting Rings and Scope (purchased separately)***

**Flat and ribbed plates:** Our flat and ribbed plates are constructed with keyhole slots at the location where your mounting rings attach. This feature enables you to partially loosen the screws on your rings just enough to insert them into the larger part of the keyhole, then slide the rings to the narrow part and tighten them with a hex key. We prefer this keyhole method to the standard way of completely removing the screws and dropping them in the grass.

We suggest that you install the rings on the mounting plate, then open the rings, lift the scope in place, close the rings and tightened the knobs. To balance the scope, you can loosen the knobs enough to slide the scope forward or backward as needed.

Another approach is to attach the rings to the scope beforehand, then lift onto the mounting plate. However, the rings must be spaced exactly the correct distance apart to match the holes in the plate. This maneuver may be particularly difficult to accomplish with a large, heavy instrument.

**Dovetail plates or sliding bars:** Attach mounting rings to the male dovetail plate (sliding bar) matching the appropriate threaded holes on the bottom of the mounting ring. Again, you have the option of attaching this dovetail/ring assembly to the mount and then lifting your scope in or placing the scope in the rings, then lifting the entire assembly to the female mounting plate already attached to the mount. Dovetail plate / sliding bar combinations are quick, versatile and convenient – hence their popularity. Simply loosen the knobs and “tilt” the sliding bar into place in the dovetail receiver. Once in place, tighten the knobs to lock everything securely. Loosen the knobs and slide the scope / rings / sliding bar assembly in the dovetail channel as needed to balance the system, and then re-tighten when balanced.

## ***Polar Alignment – Part 2 - Fine Polar Alignment***

For casual observation, you may skip this section and simply start observing. Don't forget to tighten your altitude locking knobs (2) and pier knobs (4 – Standard Pier Adapter and Hi-Lo Latitude Wedge only) before you begin! Move the telescope manually or by using the N-S-E-W buttons of the keypad. The keypad and GTO Servo Control Box will function as soon as they are plugged in. That means that the R.A. axis will be tracking up to the limits of your polar alignment. However, if you plan to use any of the go-to functions of the 1200GTO or do astrophotography, you must perform a more accurate polar alignment. Some methods, procedures and tips are presented below. However, you will complete this alignment when your scope and other equipment are mounted.

### **Methods for fine polar alignment**

- **Polar Alignment Scope** – Our optional polar scope (PASILL4L or earlier models) will allow you to quickly align your mount on the pole stars. The reticle was designed for use in both the Northern and Southern hemispheres. Even users of the GTO computerized mounts will find these polar scopes useful, particularly if your telescope is not orthogonal to the mount (please refer to the keypad manual for a discussion of orthogonality). If you have a polar alignment scope, please read the instructions sheets that come with it. If you are planning long exposure astrophotos or imaging, we

suggest that you use the polar axis telescope, then tweak the final polar alignment by using the GTO keypad and, perhaps, CCDOPS from SBIG (discussed below) or other similar alignment program.

- **GTO Keypad** – Please refer to the instruction manual for the GTO Keypad and read the sections from “Getting Started” through “Alternate Polar Calibration Routines & Tips.” Also, be sure to read the Keypad Addendum if there is one, as it may contain refinements to the keypad methods. As time goes on, the keypad manuals will be updated. Please refer to the Technical Support section of the website for the most recent documentation. Here are summary descriptions of several techniques for polar alignment from the current Keypad Manual and Addendum.
  - The Keypad startup routine provides two methods: The North Polar Calibrate and the Two Star Calibration. These two polar alignment methods were really designed for quick coarse alignment in the field with portable setups. They are most appropriate for visual observers. The Two Star Method is generally the better of the two as it is less affected by orthogonality issues.
  - The Daytime Routine (See “Polar Aligning in the Daytime” in the Keypad Manual), is a great trick for daytime setup. In addition, it is the recommended first step in alignment for anyone in the southern hemisphere, and for owners of the 3600GTO. Even those in the south who own our polar scope will find it helpful, since it will generally put the rather difficult-to-spot southern stars into the polar scope’s field of view.
  - The original GTO Quick Star Drift Method of Polar Alignment that takes advantage of the Meridian Delay feature of the Astro-Physics Servo System is also included in considerable detail in the Keypad Manual. A table of suggested stars is found in Appendix I of the manual.
  - Saving the best for last, we have also included a second Revised GTO Quick Star Drift Method that was conceived for use with a finder scope. This method was introduced in the Keypad Version 4.17 Addendum and includes a one-page Quick Reference Sheet to use once you are familiar with the method. By using a finder scope, you are able to remove orthogonality issues from the process, making subsequent alignments much easier.

For our testing purposes here at Astro-Physics, using one of the first production 3600GTO’s, we obtained accurate enough polar alignment for extensive imaging (with a focal length of 3810 mm!) using the Daytime Routine, followed by the Revised GTO Quick Star Drift Method, and did so in less than one half hour! The combination of Daytime Routine followed by the Revised GTO Quick Star Drift Method is our recommended procedure for anyone in the southern hemisphere, or anyone who finds their view of the pole obstructed.

- **Computer Software Solutions** – There are many software packages that include aids to polar alignment. Some work better than others. Most of them have shortcomings, especially if there is any orthogonality error or flexure in your system. We have seen customers practically tear their hair out trying to get good alignment using software. Do not be fooled into thinking that your alignment is perfect simply because a piece of software told you so. Polar Alignment is, after all, entirely a mechanical issue. With the creation of the Revised GTO Quick Star Drift Method, Roland and other staff members here at Astro-Physics no longer depend on software for polar alignment, although we do still take advantage of software’s capacity to speed up final critical drift alignment. Having said that, here are some of the software options that are available:
  - There is a Polar Alignment Wizard in the Full Version of PEMPro 2.x that is included with your 1200GTO. This wizard is quick and easy and gives excellent results! Details are in the PEMPro documentation.
  - We suggest that you refer to detailed instructions in the GTO Keypad manual for a method that utilizes CCDOPS from Santa Barbara Instrument Group (SBIG) for precise polar alignment. This method is basically traditional drift alignment with CCDOPS and your camera precisely measuring the drift for you.
  - There are also other similar alignment procedures, including one in MAXIM DL from Diffraction Limited. Numerous other software solutions are also available.
- **Star Drift method** – Traditionally, this very time-consuming procedure has been regarded as the most accurate method of polar alignment. However, if you are using the old method of drift alignment that employs stars near the eastern or western horizon, you may encounter problems from atmospheric refraction, which will skew your alignment. To obtain more accurate results, choose stars somewhere near the celestial equator due south or slightly east and west, but not below 45 degrees elevation.

For portable setups, we believe that our two GTO Quick Star Drift Methods (found in the keypad documentation as noted above) are much more practical approaches in terms of providing highly accurate alignment and still leaving enough time to actually get some imaging done. A permanent observatory setup where long unguided exposures are taken may still benefit from a final tweaking using the traditional star drift method (as modified by the 45 degree elevation recommendation above) or from a software enhanced variant that allows a CCD to measure and calculate the drift much faster than can be done at the eyepiece.

- **Helpful Advice** – Members of the ap-gto Yahoo group occasionally discuss alternative methods of polar alignment that they have found helpful. We suggest that you participate in this Internet discussion group. Follow the links from the sidebar of our website to find the group.

## Altitude and Azimuth Adjustments

The mechanics of altitude and azimuth adjustment are relatively straightforward. In the discussion below, we will provide some information and tips that will give you the greatest success with your 1200GTO regardless of the method you choose for determining the amount and direction of each adjustment. We'll leave the choice of method up to you. (Did we mention the Revised GTO Quick Star Drift Method?) We list the fine altitude adjustment first because our Revised GTO Quick Star Drift Method begins with altitude. Many texts for the classic star drift method begin with the azimuth adjustments.

When you made your rough alignment earlier, you loosened everything up, got the mount close, and then tightened everything back down. Any minor shifting that occurred from locking things down tight was of no consequence since it was a rough procedure. Now you are fine-tuning the alignment. Regardless of whether you start with altitude or azimuth, begin the fine adjustment process with **everything** locked down as if you were already finished. Then, loosen only what is required to make the adjustment, and loosen as little as possible. Your final adjustment should always be with everything virtually, but not quite fully locked.

### ***Fine Altitude Adjustment***

Slightly loosen the two altitude locking knobs, but do NOT loosen the polar axis pivot screws. Move the polar axis up or down with the large altitude adjustment knob located in the front of the polar axis assembly. If lowering the axis, you may need to "help" the axis down if your lock knobs are somewhat tight. If you lower the axis, always be sure that the axis remains in firm contact with the brass thrust pad. The tommy bar can be positioned in any of the threaded holes located in the altitude adjustment knob. Use this bar for your final, very small adjustments to help you turn the knob. Please refer to the illustrations earlier in this manual if you are unsure about these parts. It is also possible to make fine altitude adjustments by using the turnbuckle on the north leg of our pier, if used.

### ***One full turn of the altitude knob is approximately 0.5 degrees (30 arc minutes)***

You must be locked down in azimuth before making your final altitude adjustments, even if you will be loosening up a bit to tweak the azimuth after the altitude is finished. It is especially important that the rear azimuth lockdown knob be tightened fully so that the mount base is incapable of any slight forward tilt during the final altitude adjustments.

### ***Tips for Adjusting the Altitude***

1. The mount's polar axis is held in place between the two side plates. It is possible for the mount to shift slightly when the locking knobs are fully tightened down after adjustment of the altitude angle. To prevent this shift, it is suggested that the initial fine altitude adjustment be done with these knobs hand snugged, and as you approach the final adjustment point, tighten the knobs, first to hand tight, and finally with a hex key after each small movement. As you converge on the pole in altitude, each successively smaller adjustment is made against greater resistance from the ever tighter lock knobs.
2. Approach the pole from below and try not to overshoot. If you accidentally move the axis too high and overshoot the altitude angle, it is better to loosen the two lock knobs a bit, and bring the axis back down a very small amount before proceeding back up with the knobs tightened up again. This way you are using the weight of the mount to insure a solid connection to the altitude adjuster. During the final "tweaking" adjustment phase, with the locking knobs quite tight, screw the Tommy bar into one of the holes in the altitude adjuster knob. This bar can then be used as fine adjustment tool and is a good indication of the position of the axis.

### ***Fine Azimuth Adjustment***

When designing the Heavy Duty Azimuth Adjusters for both the 900 and 1200 mounts, we debated using an azimuth adjuster with a single captured threaded rod passing through a stationary azimuth block to avoid the two step process of backing off one side, and then adjusting the other. However, we found that the inevitable backlash in this type of system made adjustment more problematic and less precise.

The one-piece Azimuth Adjustment assembly makes for easy and accurate polar alignment in your observatory or in the field, and it eliminates issues of adjustment backlash. The heavy-duty construction and integrated one-piece design result in smooth control of the azimuth axis. Large left and right adjuster knobs are graduated for precise control of azimuth position angle.

### ***The small graduations are 1.06 arc minutes per graduation; long graduations are 5.3 arc minutes per graduation; one full turn is 31.8 arc minutes or .53 deg.***

The size of the knobs makes them easy to turn with very little torque required, even with the mount fully loaded. Take full advantage of the graduation marks on the Azimuth Adjuster when performing fine alignment to mark your starting and ending points for each adjustment. This will allow you to exactly undo any adjustments that are made in the wrong

direction. Do not leave the knob you have backed off loose. When finished, both knobs must be tight against the azimuth adjuster block to hold the azimuth angle you have set. If you follow our hint below, the act of adjustment will leave the adjusters tight against the azimuth adjuster block!

**Important Hint:** The natural tendency when making azimuth adjustments is to first back one adjuster knob off a significant amount, then make the required azimuth adjustments with the other knob, and then when finished, to tighten the first knob back up against the azimuth block. This can result in a slight shift as the first knob is tightened against the block.

We recommend that you completely abandon this approach for fine azimuth adjustment. Instead, start with both knobs tightened against the azimuth adjuster block. Then, ***back off the first knob only by the small amount of the adjustment you plan to make.*** Use the graduated markings on the knob to mark your starting and ending points. For example, if you are already pretty close, you might try backing off just two small graduations, or roughly 2 arc minutes. Finally, make the actual adjustment by tightening the other knob thereby making the tiny adjustment you required and eliminating any shift because everything is already tight when you are finished. By using the graduations, you can easily undo any errors or estimate the magnitude of your next adjustment.

The procedure for making azimuth adjustments is somewhat different with the Precision-Adjust Rotating Pier Adapter (1200RPA), Standard Pier Adapter (1200SPA) and Hi-Lo Latitude Wedge Assembly (1200WDGA) as discussed below. If you are using your own pier adapter or one provided with the Particle Wave Technologies Monolith Pier, there may be additional considerations to achieve smooth, accurate adjustments.

### ***Precision-Adjust Rotating Pier Adapter with Azimuth Bearing (1200RPA)***

The Precision-Adjust Rotating Pier Adapter consists of two plates that allow ultra-smooth adjustments for critical polar alignment. When using the Precision-Adjust Rotating Pier Adapter, tighten the pier knobs fully by hand. It is not necessary to use a wrench, but you want the pier knobs at their final level of tightness before you start adjusting. These will remain tight during and after the adjustment procedure. Also please note that the altitude axis should be fully locked down with a hex key before adjusting the azimuth.

Azimuth adjustment is accomplished with the two fine azimuth adjustment knobs, one on each side of the mount. Make your azimuth adjustments as described above and be sure to take note of the Important Hint! When your azimuth angle is perfect, you are finished. There is nothing further to tighten or to lock down, and you don't need to worry about the dreaded shifting that inevitably follows such lock-downs. Follow one of the alignment methods discussed above in the Polar Alignment section.

Notice the two setscrews on the side of the Precision-Adjust Rotating Pier Adapter. These setscrews are used to apply tension to the rotating plate. You may, on rare occasions, need to adjust these setscrews to gain the proper feel during the adjustment process. If you notice a slight amount of shift, particularly with a larger scope, carefully tighten the screws a small amount. DO NOT overtighten! If you find too much resistance, the screws may need to be loosened slightly. (See pier adapter section earlier in manual.)

### ***Standard Pier Adapter (1200SPA) and Hi-Lo Latitude Wedge (1200WDGA)***

Each of the azimuth lockdown knobs has a hardened washer. With these washers, the lockdown knobs can hold the mount down tight while still allowing the axis to be easily adjusted with your fingers turning the large knobs of the Heavy Duty Azimuth Adjuster. These washers will eliminate minor shifts in the axis when you are tweaking your azimuth adjustment.

**Note:** The washers have a sharp-edged side and a rounded-edge side (the difference is subtle). Place them with the sharp edge of the washers facing up toward the knob, rounded edge down onto the painted surface of the base plate. If you install the washers with the sharp edge down, they will bind into the paint and prevent smooth movement. If you do not have a permanent installation, you may wish to mark the down side of the washer with a permanent marker so that you can quickly identify the desired orientation.

1. The altitude axis should be fully locked down with a hex key before adjusting the azimuth.
2. Follow one of the methods of polar alignment mentioned above.
3. During the initial adjustment phase, the front and two side lock-down knobs should be hand snugged only. The rear knob should be relatively tight. This will allow easy movement of the azimuth axis.
4. Make your azimuth adjustments as described above and be sure to take note of the Important Hint! When you are close to the final position of the azimuth axis, use a hex key to lock down the rear knob only. The azimuth can still be moved with the adjusters, but it will now be solidly connected to the pier top. The other knobs should remain hand-tight. The weight of the mount and scope puts pressure on the front of the plate for a solid connection, so it is not necessary to lock them down fully with a hex key until all adjustments are finished.

# CLUTCH KNOBS AND BALANCING

## *Understanding the R.A. and Dec. Clutch Knobs*

We suggest that you read this before assembling the remainder of your system.

1. What do they do?

The four R.A. and four Dec. clutch knobs depicted in the Assembly Diagram on page 6 have the function of connecting the R.A. and Dec. axes to their respective drive worm wheel gears. Their function is progressive, from no tension (axes free to move - as required during correct balancing of the telescope) to a completely "locked up" state.

2. How can you find out what they really do?

As shipped, all 1200 mounts have all four R.A. and Dec. clutch knobs firmly hand tightened. This will give you a good idea of the maximum tightness (clutch action) that can be achieved by hand effort alone. At this point, you must bear in mind that for optimum performance all four clutch knobs on each axis (R.A. or Dec.) should be tightened evenly with the same tension i.e. all four half tight, all four fully tight, etc.

In order to feel the effect of the clutch knobs, you may wish to partially assemble your mount. Fit together the R.A. and Dec. assemblies plus mounting plate and counterweight shaft. Do not put scope and counterweights on at this stage. With the above assembly (with the clutch knobs firmly hand tightened - "as shipped"), you can feel the amount of force needed to move each axis by hand. Grab each end of the telescope mounting plate and move it with a backward and forward movement of the Dec. axis. You will feel considerable resistance to this motion. Perform the same operation on the R.A. axis by moving the counterweight shaft backward and forward. With a well-balanced telescope, the above tightness of the clutch knobs will be sufficient for all normal conditions of use.

Now, if you proceed to mount up and balance your telescope, you can "feel" what this resistance in R.A. and Dec. (movement backwards and forwards) is like when you make these motions from the eyepiece end of your telescope as you would during normal use when slewing (pushing) by hand to acquire an astronomical object within the field of view of your finder or scope.

3. How tight can the clutch be and can you do any damage by pushing against them?

The maximum tightness of this clutch system is 1/3 turn (with a 5/32 hex key) further in than the tension you can achieve with the knobs by hand. You will see that each clutch knob has a 5/32 hex socket for tightening with a hex key. With this extra 1/3 turn on each clutch knob, the axis (axes) will be considered completely "locked up" and you should not attempt to push your scope by hand against this "locked up" resistance, or undue stress will be placed on the worm wheel/worm and bearings.

However, if you are undertaking a very long astrophoto exposure, it is advisable to increase the pressure on each clutch knob (with the 5/32 key) by about 1/8 turn past hand tight on Dec. and 1/8th turn past hand tight on R.A. You may safely slew the scope by hand with this tension, however you will notice considerably more effort is required to achieve movement. This is the absolute maximum tension that can be used for hand slewing. As a general rule, if you have a big scope (7" or 8" refractor) with all the accessories, you will need more clutch tension than a 5" or 6" scope.

**WARNING!** Resist the urge to over tighten the clutch knobs with the hex wrench. This will only cause them to deform and lock into position. If you find that you are no longer able to adjust the tension and the knobs are locked firmly in place so that the axis will not move, please refer to the Clutch Plug Replacement Section at the end of this manual.

## ***Balancing Your Telescope***

For proper operation, the telescope must be adequately balanced along both axes. Start by balancing the tube assembly.

### **First, Balance the Declination Axis**

1. Position the mount for balancing. Move the R.A. axis so that the counterweight shaft is pointing down. The declination axis assembly will be in the meridian (this is the classic photographic pose for a German Equatorial). Position the Dec. axis so the telescope tube is horizontal and pointing east.
2. Tighten the 4 R.A. axis clutch knobs.
3. Loosen the 4 Dec. axis clutch knobs (about 3/4 to 1 turn) so that the telescope moves freely about the declination axis. Be careful because if your telescope is significantly out of balance, it may swing rapidly in the out-of-balance direction!
4. Loosen the tube mounting rings and slide the tube back and forth for balancing. This is best done with the tube in the horizontal position. If you are using an Astro-Physics or Losmandy dovetail mounting plate, loosen the hand knobs on

the female dovetail plate and slide the male plate and telescope to the desired position.

5. The scope is balanced when it stays put (does not move) with the clutches loose and movement back and forth about the declination axis has the same feel in both directions. Be mindful of eyepieces, cameras and other accessories that are yet to be added and compensate accordingly.

## **Second, Balance the Polar Axis**

1. Now, tighten the declination axis clutch knobs and position the mount with the telescope horizontal and the declination axis horizontal. The counterweight shaft is now horizontal with the center of the counterweights the same height as the middle of the tube.
2. Loosen the R.A. clutch knobs. Again, be careful because if your scope is significantly un-balanced, it may swing rapidly in the out-of-balance direction.
3. Move the counterweight(s) up or down to achieve the correct balance in R.A. Again, movement back and forth about the R.A. axis should have the same feel in both directions.
4. Re-set the tightness of all 8 clutch knobs to the resistance you want making sure that each axis' 4 clutch knobs are evenly tightened. (See section on clutch knobs above.)  
Try to anticipate any balance problems due to the extra weight of diagonals, heavy eyepieces, finders, solar filters, etc. If the scope moves by itself, when the clutches are loose, then the scope is not balanced adequately. You may want to "tweak" by carefully repeating steps 1 – 5 after everything has been attached to the telescope. Be especially careful loosening the Dec. clutch knobs.

NOTE: A small amount of imbalance on the East side of the mount is permissible and is considered by some to be desirable for astrophotography and imaging. It is not really necessary with the 1200GTO because of the mount's high level of worm precision, but the practice is often touted in astrophotography guides, so we mention it here. Remember that if imaging several objects on different sides of the sky, you will need to re-adjust the balance to keep the east side slightly heavy after a meridian flip. This advice, then, obviously only applies to "hands on" imaging setups where you are physically at the mount to adjust the balance if needed. Remote imaging setups should aim for a balanced state. Roland never follows the practice of setting the east slightly heavy in his own imaging.



# SERVO MOTOR DRIVE

## ***GTO Control Box – Model GTOCP3***

The GTO control box contains all of the circuitry to drive the two servo motors and the logic required to navigate the sky. It will be operational and track at the sidereal rate when connected to both motors of the mount and a power source. In order to control the movement of the mount, you will need to connect at least one of these:

- GTO Keypad.
- PC computer with PulseGuide by Sirius Imaging. The CD with this program is included with the mount. The CD includes a complete user's manual in PDF format. For the most updated version of the software, check out the website [www.pulseguide.com](http://www.pulseguide.com). Please refer to the section later in this manual for further information regarding the capabilities of this program.
- Computer with a planetarium program such as Software Bisque's *TheSky*™, Simulation Curriculum Corp.'s *Starry Night*™, Nova Astronomics' *The Earth-Centered Universe (ECU)* version 3.1 or later, and Chris Marriot's *Sky Map Pro 6* or any ASCOM compatible telescope software (all purchased separately).

The GTO Servo Control Box is mounted directly onto the polar axis of the 1200GTO mount. Please remember that this box contains advanced electronics and must be treated with the same care given to other fine equipment. You can see that the unit is machined of aluminum and is built to be rugged; however it is not indestructible.



## **Pre-loaded PEMPro™ Curve**

Your mount was tested at our production facility with a special version of PEMPro™ Periodic Error Management Software. After ensuring that the mount's uncorrected periodic error is within our specifications of 7 arc-seconds peak-to-peak, we generate a unique optimized PE curve for your specific mount, and then save the corresponding PE correction curve to the GTOCP3 control box for you to use. By turning PE on from the keypad, you can take advantage of this PE curve the very first time you use your mount. This PE curve should remain valid for several months as your gears "run in" and will probably suffice for many mount owners. Instructions for turning the PEM on in the keypad's "Tools" menu are found in the keypad manual.

The full version of PEMPro™ v.2.x has, of course, been included with your 1200GTO, so you can actually produce an even more refined periodic error curve by using more worm cycles than we can do here at the factory. Although we can make no promises, we have heard numerous reports of sub-arc-second periodic error from experienced users running 6 or more worm cycles in PEMPro™!

It is suggested that you save the existing curve to your computer before overwriting it in the control box with a new curve, just in case you do something wrong in your first attempt at a PEMPro™ run. That way, you can re-load the old data back to your control box, if needed.

## Lead-Free Electronics

Starting in 2006, we began phasing in lead-free electronics for all of our mounts. In the first phase, all GTO mounts (and other electronics) shipped to customers in the European Union were built with lead-free electronic components due to RoHS regulations that went into effect on July 1, 2006. As of mid 2007, all of our electronics adhere to this safer and more environmentally responsible standard. All functions and capabilities of the Servo System were maintained with the lead-free components.

## R.A. and Dec. Cable Connections

A “Y” cable with 10-pin connectors is included with your mount. Attach the connector from which the two cables emerge to the GTO Control Panel. Attach the short part of the “Y” cable to the R.A. motor housing and the long part of the cable to the Dec motor housing. Lock all connectors. Refer to the section below for further information about positioning the cables.

## 12V Connector

Place the DC power cord (included with your mount) into the DC power plug outlet marked 12V on the GTO Control Panel and lock in place. Plug the cigarette lighter plug end of the cord into your power source. The acceptable voltage range is 11.5 to 16. Above 18V is not recommended. Suggested power sources include: portable rechargeable battery pack, auto or marine battery, or power supply (filtered and regulated) for standard household AC current (110-115 volt – 60 Hz in the US) with a minimum output of 5 amps at 12V DC. 13 to 16 volts is recommended for best performance, but please note that for most applications, 12 volts is fine. We also recommend that the mount have its own dedicated power supply and that other devices be powered from a separate source or sources.

There is no on-off switch. We recommend that you plug the power cable into the power source after the keypad controller is attached to the GTOCP3. To turn the unit off, simply disconnect the power cable.

**Considerations for observatory installations:** We suggest that you disconnect your GTO Control Box from 110V and any other device (CCD camera, computer, etc) when you are not using your mount so that if your observatory experiences a power surge or lightning strike, your mount electronics will not be damaged. If you operate your mount remotely, you will have to leave your power cable connected just as you do for the rest of your electronic equipment. You may want to consider surge protectors or other protective measures to protect from voltage spikes. A disconnect relay to remove power from both the 12-volt and ground wire is highly recommended in this situation.

## POWER Indicator Light

This red LED will remain illuminated when your system is powered up and operating properly. The red-colored LED indicates proper functioning of the servo system. If the servo detects a problem, the LED will turn from red to amber. An amber LED indicates that the servo has gone into “safe mode” or “motor stall” mode and is no longer trying to drive the motors. The motors will be stopped. Position data is not lost during this condition. If the voltage falls below about 10.5 volts, the power LED will go out completely. The keypad will also not function properly below about 11 volts. (Note: GTO Control Boxes shipped before 02-25-00 do not have the dual color LED feature.)

If you experience an amber LED, first check your power source to be sure it is delivering adequate voltage and current to drive the system. If your power supply is good, the amber LED means that your motors are overloaded, probably due to an unbalanced load on your mount. Refer to the troubleshooting section of the manual for the solution.

## KEYPAD Connector

Attach the 5-pin male connector of the keypad controller and lock in place (push in the knurled ring then turn).

## RS-232 Connectors

These serial port connections are used to connect your mount to your external computer. Beginning in December 2008, we began shipping all mounts with a 15' straight-through (non-crossing) serial cable with a 9-pin (DB9) male connector to interface with the GTOCP3 Control Panel. We also provide the locking posts to secure the cable firmly onto the control box. If you purchase a serial cable that does not have a 9-pin connector, you can use a gender changer or adapter to convert it. **Please note:** *the use of “crossing,” “reversing,” “null,” or “null modem” cables is a frequent source of failure and frustration. Make sure that your serial cable is wired straight-through!*

When you are controlling the position of the mount with a computer program such as *PulseGuide™*, Software Bisque's *TheSky™*, or Simulation Curriculum Corp.'s *Starry Night™*, the microprocessor chip located in the servo drive box will send continual RA and Dec. coordinate data via the cable connections to your computer. When you use the software to

give instruction to slew to a new object, the commands (RA and Dec. coordinates) are sent to the mount. Please read the section that follows entitled Controlling Your GTO Mount.

We provide two serial-port connections on the mount so that you can use two software programs simultaneously (in addition to any auto-guider software that may be sending signals to the mount through the Auto-guider Connector). For instance, you can use *PulseGuide* for advanced mount control, while using *TheSky* as a planetarium program. The telescope control functions of *TheSky*'s native driver are more limited, so using both in a remote application is advantageous. Since the mount will update the RA and Dec coordinates simultaneously, both programs are continually updated with the data from the mount. You can watch the screen display of *TheSky* to see where your telescope is pointing as it slews. This is most effective if you have a reasonably fast computer with plenty of RAM. If you try this with a 100MHz processor and only 32 MB of RAM, the response time will be slow since both programs must be continuously updated with position data.

You must have two serial ports available on your computer to take advantage of this feature. If you use a laptop or a newer desktop computer, you will probably need to purchase a USB to Serial Adapter. Starting in the spring of 2008, Astro-Physics began offering single port and four port USB to serial adapters made by *Keyspan*<sup>™</sup> that we have found to work quite well on our own equipment (USB1P & USB4P). The serial ports on the GTOCP3 control box allow remote operation of your mount, a handy feature for catching those winter pretties from the warmth of the house, or for using the mount at a remote dark sky site that is miles from home.

For remote control of a mount that is within 100 yards or so of the controlling computer, we have found the Icron Technologies USB Ranger 2104 USB extender (available from Astro-Physics in early 2010) along with the Keyspan USB to serial adapters mentioned above to be an excellent solution. The USB Ranger 2104 provides four USB ports, one of which is used by the four port USB to Serial Adapter, leaving 3 available USB and four available Serial ports at the mount. The Icron USB Ranger 2104 supports isochronous data transfer and will therefore work with CCD cameras including those from SBIG with no appreciable loss of download speed.

More distantly remote observatories will generally require a computer or IP addressable server in the remote observatory itself, and a high speed internet connection for communication with your home computer. Such solutions are beyond the scope of Astro-Physics to supply or support.

For a more detailed discussion, go to our website: [www.astro-physics.com](http://www.astro-physics.com). We also recommend that you go to the Yahoo ap-gto user's group (access it through our website) and type "serial", "usb" or "pcmcia" into the search box. Also, be sure to keep an eye on the "What's New?" pages of the website for further developments in this area.

## **FOCUS Connector**

If you have a motorized focuser with a DC synchronous motor (like the JMI Motofocus), you can attach the 3.5mm phono plug connector here. This connector can NOT be used with motorized focusers that use stepper motors as they require their own separate drivers. Refer to the section regarding focus adjustment in the GTO Keypad Manual for instructions on using the keypad controller to adjust focus.

## **RETICLE Connector**

If you wish to use the illuminator cable for our Polar Alignment Scope (PASILL4 or earlier models), a plug-in type guiding eyepiece with an illuminated reticle (available from several manufacturers), insert the 3.5mm phono plug into this connector for power. Reticle brightness can be adjusted with the keypad. Refer to the section pertaining to reticle illuminator adjustment in the GTO Keypad Manual for further information.

## **AUTOGUIDER Connector**

This connector interfaces with the RJ-11-6 modular jack of an autoguider cable, purchased separately or as part of a CCD Imaging Camera or Autoguider. The autoguider will be functional and ready to go as soon as you plug it in. Please refer to the appropriate manual from the manufacturer for operation of the autoguider.

## **+6V Connector**

This 6-volt output accepts 3.5mm phone plugs. It's original purpose was to power the Pentax 6x7 camera directly from the mount. Its most common usage today is to power the StarGPS. It has also been used to power Bluetooth units for wireless connection to the mount's COM ports. Center is positive. It will supply up to 200mA of current. Be sure of your device's power requirements and polarity before attaching!

## N and S Switch

Select northern (N) or southern (S) hemisphere as needed. When you slide the switch to the opposite position, the tracking direction of the drive will reverse. The power cord must be removed and re-attached to make this work.

## Drainage Holes

Two holes are drilled into the lower portion of the bottom of the control box. These holes allow excess moisture to drain from your control box, particularly useful on dewy nights. Please do not plug these holes.

## Removing the GTO Control Box From 1200 Mount

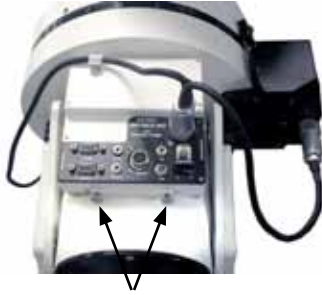

The GTO control box can be removed easily from the RA axis. It is secured by two 8-32 set screws located at the base of the GTO Servo Control Box. Loosen the screws with one of the hex keys from the set included with the mount. Lift the box up from the bottom and tilt so that it frees from the dovetail connection.

Some people have a permanent observatory, yet prefer to store their electronics in their home to keep them clean and free of cobwebs. If you do, you may wish to substitute the 8-32 thumbscrews (included with your mount and shown in photo) for the setscrews. This will allow you to remove and install your GTO control box without tools.

# CONTROLLING YOUR GTO MOUNT

Your Astro-Physics 1200GTO has a remarkable servo control system that combines with the precise mechanics of the physical components to give the mount its superb performance. Contrary to popular assumption, the brains of the mount are not found in the keypad, nor are they in an external computer that is used to send the mount pointing here or there. The real brains of the Astro-Physics GTO Servo Control System are in the GTOCP3 control box. Simply think of your keypad or computer as being an input device for the GTOCP3. If you understand this from the start, you will always have a better concept of how things work, and you will be less likely to make operator errors.

## ***GTO Keypad Operation***

Please refer to the manual for the GTO Keypad Controller for complete instructions.

## ***Pulseguide by Sirius-Imaging***

PulseGuide™ is a stand-alone Windows (98, ME, 2000, NT4, XP, Vista and Windows7) utility that provides complete remote control of all Astro-Physics GTO mounts. It derives its name from its most distinctive feature, pulse guiding, which can improve unguided tracking. Specifically, it can help correct tracking errors caused by polar misalignment and atmospheric refraction. You can also train PulseGuide™ to track objects moving relative to the stars, such as asteroids, comets, and the moon. In addition to pulse guiding, PulseGuide™ also has many useful utility features. PulseGuide™ was written by Ray Gralak of Sirius-Imaging. The complete PulseGuide™ user's manual is included on your PulseGuide™ CD in PDF format. Please read it carefully to take full advantage of this powerful mount control software. See [www.pulseguide.com](http://www.pulseguide.com) for the latest information.

## ***PEMPro V. 2.x (latest release) by Sirius-Imaging***

PEMPro™ (Periodic Error Management Professional) is a Windows software application that makes it easy to characterize and reduce periodic error. PEMPro™ will analyze the performance of any mount that is equipped with a CCD camera and compatible camera control software. PEMPro™ gives you powerful tools to program your mount's periodic error correction firmware to achieve the best possible performance for your mount. PEMPro™ dramatically improves guided and unguided imaging resulting in better images and fewer lost exposures.

The uncorrected periodic error of your 1200GTO will be 5 arc seconds or less when it leaves our facility. We will have reduced this already small native error significantly by loading the error curve from our extensive testing procedures into the servo system. The resulting error that remains should be negligible, and will probably be satisfactory for all but the most demanding applications. You can, however, reduce the error even further to maximize performance without auto-guiding by recording a much longer run with PEMPro™ that will average more complete cycles of the worm.

As a normal item of mount maintenance, you should plan to redo your PEMPro™ run once a year (more or less depending on usage) to compensate for gear run in. If you ever remove your motor / gearbox or manually turn the worm gear, you will also invalidate any previously recorded corrections and will need to do a new PEMPro™ run. (Manually moving the telescope does NOT turn the worm gear, so that is not a problem!) Complete documentation is provided in the help menu of the installed program. Also, please read the Important Information HTML file on the CD before loading PEMPro onto your computer.

## ***The Astro-Physics ASCOM V2 Driver***

Astro-Physics began the development of a company-supported ASCOM V2 driver in 2009. Please see the Astro-Physics website for current information on the ASCOM driver.

<http://www.astro-physics.com/products/accessories/software/ascom/ascom.htm>

# CABLE MANAGEMENT

The movement of the mount across the meridian during slewing functions is calculated so that the cables will not tangle if they are set up properly. In addition to the motor and power cables that are provided with the mount, you may have additional cables for other accessories. These may be powered from the GTO Control Panel or from another power source. We suggest that you position your cabling carefully to avoid a tangled mess. When your cables are set up, move the telescope manually throughout the normal range of movement to be sure that the cables do not catch on anything and that you have enough length. Here are a few pointers:



## 1200 Motor Cables

Note that the “Y” cable for the 1200 mount originates at the GTO Control Panel connector, and then splits into two. The short portion connects to the RA motor box and is not likely to be in the way because this axis remains in the same position. We have provided a cable mount to position the Dec cable neatly. The longer Dec portion of the cable must be set up properly to ensure that as the Dec axis moves, the cable follows smoothly. Please insert this cable into the cable mount in the upper left corner of the GTO Servo Control Box as shown above. When the connector is attached to the Dec motor box, the cable should be positioned as shown in the photograph.

## Accessory Cables

Accessories may include Kendrick Dew Removers, CCD cameras and autoguiders, focus motors, illuminated guiding eyepiece reticles, power cords for the Pentax 6x7 camera, etc. As you attach each accessory, carefully assess the best position to assure complete movement as your telescope slews from one side of the mount to the other. If an external power source is used, determine the optimum location for the battery. Beginning with the 2007 production run, we have supplied a half-dozen nifty Velcro cable-ties to assist you in this important and often overlooked little housekeeping chore. Use the cable-ties to secure your various cables to the mount, telescope, rings or to bind them together. Adhesive cable mounts similar to the one that we use for the Dec. cable are also an alternative choice. We prefer to use the Velcro cable-ties since we cannot bear to attach adhesive cable mounts to our beautiful telescopes or mounts.

## Optional Accessories to Prevent Cable Snags

Those of you with permanent installations may wish to consider replacing the clutch knobs and dovetail knob on the side with the declination cable with our M12668 Modified R.A. Clutch Set Screws and a DOVEKBREP Replacement for 900/1200 Dovetail Knob. Note that these optional items are available for purchase on our website or by calling Astro-Physics.

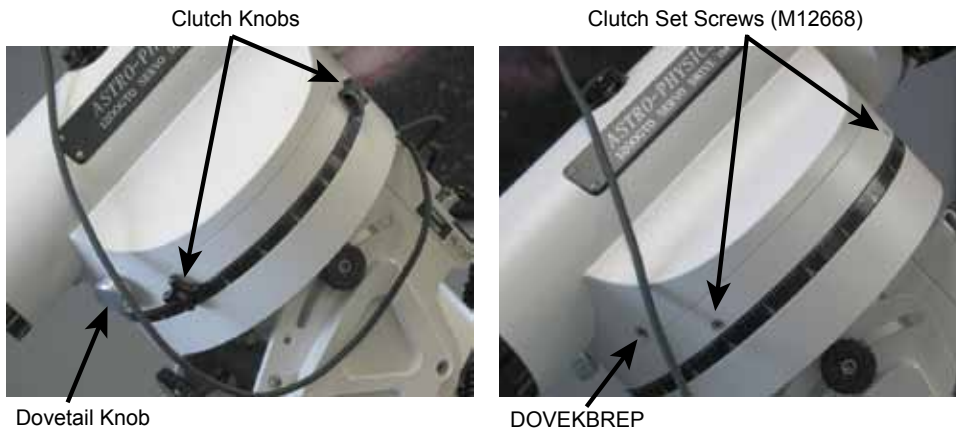

## **Example from International Space Station – Amateur Telescope (ISS-AT) Project**

If we use tie wraps to secure several cables together and plan to use that same setup in our next observing session, we keep the ties in place when we disassemble our equipment. The setup for the next session is much quicker.



The photo on the left shows how the cables were arranged on the 1200GTO that was installed at a permanent observatory for the International Space Station – Amateur Telescope (ISS-AT) project of the Astronomical League. This mount is operated remotely and cable management is essential. The scope is a modified Celestron C-14 and the accessories included: CCD camera, color filter wheel, remote focuser and Kendrick Dew Remover.

Note how the wire bundle is attached to the mounting plate before looping back to the pier. Attaching the wires securely to the plate prevents any kind of motion or disturbances to the camera during image acquisition and guiding. The loop is made long enough to allow the scope to reach all portions of the sky with plenty to spare. The people who installed system ran the scope all over and reported zero interference.



This photo shows the mount and scope with the wire loop containing all the cables from the CCD camera, color filter wheel, remote focuser and Kendrick Dew Remover. If you look closely, you will notice that the two clutch knobs were removed and replaced with special Allen head bolts. This allowed the Dec cable to slide easily over the axis in all orientations and there was no snagging of the wire anywhere. Please call Astro-Physics if you would like to order these bolts. Do not try to install normal Allen head bolts.

For a portable setup, we keep the ties wraps in place as much as possible when we disassemble our equipment. The setup for the next session is much quicker.

**Please Note:** As an additional aid to cable management, the current production models of the DOVELM2 and DOVELM162 Dovetail Saddle Plates for Losmandy “D” Series Plates feature a #10-32 tapped hole at each end to facilitate the attachment of a cable stay. See the previous section on attaching mounting plates.

# SLEWING YOUR MOUNT IN BELOW FREEZING TEMPERATURES

Notes from Roland during a very cold spell in January 2005:

“There are several potential problems when slewing your mount in below freezing temperatures. The symptoms are a wavering or chattering sound from the motors, a slowing down of the slewing with a sudden jolting stop at the end of the slew, and in the worst case, a continuous running of the motors and loss of control. I have seen similar things on my own mounts when the temperature dips below zero F. There are three things that you can look at to alleviate the problem.

First, in cold weather it takes a very much larger amount of power to slew the motors than it does in the summer (see tests I ran below). This extra current drain can cause a voltage drop in the power cord running from the supply to the servo. If you have a long distance between the supply and servo, use a heavy wire to minimize the voltage drop. If the power drops below about 11 volts at the servo terminal, the internal computer chips may reset with subsequent loss of control of the motors. If your supply is marginal, it may also not produce the voltage necessary for proper operation during slews. It is a good idea to limit the slew speed to 600x during real cold weather to reduce the power demand from the supply.

Second, it is very important to have the worm mesh not set overly tight. One symptom of overly tight worm is a chattering sound as the motors try to slew at 1200x or even as low as 600x. You can check to see if the worm turns easily with your finger by removing the motor covers and removing the large spur gear to get access to the worm end. Try turning it by hand. If it does not easily turn, then the motor will also have a difficult time turning it. Check in our technical section of the AP web site on how to set the worm mesh. In real cold weather, well below zero F, it might also be a good idea to lubricate each of the spur gears and their sleeve bearings with a light machine oil. When warmer weather returns, this can be replaced with a light grease, Lubriplate 105, which will reduce the wear factor in warm temperatures.

Third, under very extreme temperature conditions below -20F, it may be necessary to replace the grease on the worm wheel teeth with a lighter material. The mounts use a special formulation of Lubriplate 105 with a damping grease added. This combination is ideal for low wear since the damping grease portion allows the grease to stay on the teeth and not get wiped off by the motion of the worm. Although this combination works well even at temperatures below zero, it does get more viscous in really cold conditions. We have tried straight low temperature greases that work to -80F, and in each case, the worm gears get abraded very quickly. Using no grease at all is also not recommended for a GoTo system that slews at high speeds. The wear on the worm and wheel teeth is extremely high and can develop very high periodic error after a short time due to scratches and high spots that develop on the gear teeth. At this time we have no solution to ultra-low temperatures.

Last night it was -8 F here, and I tested several of our mounts in the observatory. Two are very old, from the original batch, and one is brand new. All worked well at 600x but showed signs of laboring at 1200x slewing. I use a 12-volt marine battery to power them. I replaced the marine battery with a variable power supply that I varied from 12 volts to 18 volts. At 12 volts when both motors were slewing at 1200x, the power draw was in excess of 8 amps (in summer this is around 2.5 amps). The motors were laboring and not running smoothly at full speed. I turned up the voltage to 15 volts, and the current draw dropped to around 5-6 amps. The motors worked smoothly at 1200x with no hesitation at that voltage level. I would recommend for cold weather work to get a supply that can deliver 15 - 16 volts at a rated current capacity of 10 amps. Higher than that is not necessary. Above 18 volts is not recommended.”



# MOUNT CARE, CLEANING AND MAINTENANCE

Like any fine piece of equipment, your mount's longevity and performance are directly correlated with the quality of the care that you give it. Handle it with respect, keep it as clean and dry as is practical, and perform a few minor maintenance tasks, and your 1200GTO will give you many years of trouble free service.

## Care

Although we build it to be rugged enough for field use, your 1200GTO is a precision instrument with very accurate worm and wheel adjustments. Please be careful if you place the mount on a flat surface, i.e. the ground or trunk of your car. The gear alignment may be affected if the R.A. and Dec. motor/gear box assemblies sustain undue lateral force. This is true of any fine instrument. We suggest that you transport and store the mount in a case or in a well-padded box. ALWAYS disassemble the mount before moving it or transporting it. More damage can be done in a few careless seconds in transit than in many hours of normal operation.

Try to keep your mount protected from dust and moisture when not in use. In warm, humid weather, be aware of the dew that may have formed on the mount while in the field and allow the mount to dry out before packing it away for storage once you get home. On the other hand, if it is cold and dry outside, keep the mount packed up when you bring it into the house until it reaches room temperature to avoid "fogging it up." (The same advice applies to telescopes, eyepieces and other equipment in your Astro-arsenal.)

## Cleaning and Touch-up

Wipe your mount clean with a soft dry cloth. If needed, you can use a damp cloth or a cloth that has been sprayed with a mild, non-abrasive cleaner (window or all purpose cleaner – no bleach). Do not spray cleaners directly onto your mount. If you use a cleaning product, follow with a damp cloth to remove the chemicals from the mount.

The painted surfaces of your mount may end up with scuff marks from repeated transport and assembly / disassembly. Most of the time, these marks can be removed with a product like [Color Back](#) by [Turtlewax](#) (automotive product). Simply apply with a paper towel and buff out the mark. If your paint becomes chipped, touch-up kits are available for purchase – please call us.

NOTE: Paint touch-up kits can only be sold to U.S. customers because of regulations governing shipment of hazardous materials.

## Routine Mount Maintenance

Under normal operating conditions, minimal maintenance is required. Every 12 months the clutch knobs (4 for Dec. and 4 for R.A.) should be removed and 1 small drop of light oil (3 in 1 household oil) should be put in the exposed hole. If the R.A. and Dec. axes are attached together for a long time in outside conditions (i.e. in a permanent observatory) then the mating surfaces should be lightly oiled or greased - if you expect to get them apart again after 10 years.

Jostling and vibrations associated with transport to and from observing sites has had the effect of causing screws and fasteners to work their way loose over time. We have worked very hard in both the design and assembly of our mounts to alleviate this problem, but it is still a good idea to periodically (once or twice a year) inspect and if necessary re-tighten any easily accessible fasteners. Additional maintenance information can be found below in the troubleshooting section and in the Technical Support Section of our website.

# TROUBLESHOOTING, TIPS AND SUPPORT

## *Troubleshooting and Tips*

Additional troubleshooting questions are in the GTO Keypad manual. Some of the issues discussed in the keypad manual relate to mount communication issues whether you use the keypad or control the mount with a planetarium program or PulseGuide. Please refer to them.

### **The Declination (or R.A.) axis is fairly tight, even with the clutch knobs fully loosened.**

This occurs when the clutch plugs have been damaged from over-tightened clutch knobs. Please refer to the appendix at the end of this manual for detailed instructions on clutch plug removal and how to fabricate your own clutch plug tool.

### **The LED on the GTO Control Box changes from red to yellow and the motors stop or go out completely (for mounts shipped after 02-25-00).**

1. The motors are overloaded, probably due to an unbalanced load on your mount.

Rebalance your telescope, and then press one of the N-S-E-W buttons to reset the keypad. Re-enter the last object on your keypad and the scope will slew to the correct position. Even though your motors had stopped, the logic in the control box retained the scope position in memory. As long as you didn't change the pointing position of the scope, you are still calibrated.

If the scope was moved during re-balancing, simply enter a nearby bright star on the hand controller, press GOTO and allow the mount to finish slewing. You can then move the scope manually or with the N-S-E-W buttons to center the star in the eyepiece, and press the #9 RECAL button. This will recalibrate the mount.

*Additional explanation:* The GTO drive circuit includes logic for overload protection to prevent burning out the expensive servomotors in case of severe overload on the two axes. The primary cause is an unbalanced load in R.A. If the extra load opposes the motor rotation, the motor must work harder to track at the sidereal rate and the current will rise to high levels. If the current exceeds the trip point for more than a minute, the logic will shut the motor off and tracking stops. It typically takes about 4 lb. of unbalance to trip the overload, but a very heavy load of scopes, accessories and counterweights on the mount can decrease this unbalance threshold.

2. The voltage of your battery has probably gone below 10.5 volts.
3. The current rating of your AC-DC power supply is too low.

*Additional explanation:* During slewing, the two motors draw up to 3 amps from a 12 volt source. This may increase when the temperature approaches freezing or below. It is recommended that your supply be rated at 5 amps, 12 volts DC minimum (18 volts max.). If you also power other equipment (CCD cameras, dew heaters, etc.) from the same source, you will need a supply capable of up to 10 amps. The more equipment you have, the more current capability you will need. For portable applications, we recommend a heavy-duty marine battery designed for deep discharge applications. The most common problems are due to inadequate power supply.

### **The keypad reset (or locked up) when I plugged my CCD camera, PC (or other equipment) into the same battery as the GTO mount was using. The battery has a meter, which shows 12V.**

The meter is reading an average and will not show dips. Gel cells have internal resistance, which will cause voltage drop when the load changes. When you connect an additional CCD camera and PC the load will drop below 9 volts and the keypad will reset or it may affect the GTO circuit itself and cause the keypad to lock up.

We recommend that you use a large marine battery that is not a gel cell and hook everything up to it before calibrating the GTO. Or, better yet, put the other equipment on a separate battery.

### **What is the maximum voltage that I can use to power the servo drive?**

The servo drive of the 900GTO and 1200GTO will withstand up to 24 volts without any sort of damage to the internal electronics, according to our engineer. However, above about 17 volts, the motors may become a bit jittery because of the higher gain with this much voltage. The system works very well with 15 - 16 volts. Please note that for most applications, 12 volts works just fine.

### **For polar alignment, I am using declination drift technique with stars on east & south. Now, I do not see any drifts in declination on both sites (E & S), so the mount "should" be properly aligned. However, I have still small drift in RA which looks like the RA motor is a bit faster than earth rotation. This drift is something like 1.5 arcsec during 1 minute or so & accumulates over time, so it doesn't look like periodic error.**

The sidereal tracking rate is exact in the mount (it is crystal controlled and checked here for accuracy). However, the stars do not move at exactly the sidereal rate everywhere in the sky. The only place they move at that rate is straight overhead. As soon as you depart from that point in the sky, the stars will be moving more slowly, especially as you approach the

horizons. Thus, it looks like the mount is moving slightly faster than the sidereal rate. Just because you have done a classic drift alignment, does not mean that the stars will now be moving at the sidereal rate everywhere in the sky.

In order to increase the area of sky from the zenith that will give you fairly good tracking, you will need to offset the polar axis by a small amount. The amount will depend on what your latitude is. The other approach is to vary the tracking rate for different parts of the sky. Ray Gralak's Pulse Guide will allow you to dial in an exact tracking rate for any part of the sky.

### **Initially, the mount was working fine. Then, suddenly the mount stopped tracking altogether!**

Chances are that the motor was turning properly and driving the worm gear, but that your clutches might have been loose and therefore the scope was not following the motion of the worm gear. The fact that the high slew rate did move the scope does not change this, because Roland has seen this himself where the tracking rate did not overcome the slipping clutches but the slew rate did.

If you are unsure of the motion of the motor, just remove the motor cover plate and look inside. You will see the motor turning. Sometimes when you have the clutches loosely engaged and the counterweights are somewhat out of balance, being heavy in the east, then the clutches might slip at the slow sidereal rate.

In any case, just to set your mind at ease, simply remove the motor cover next time something like this happens and look at the motor shaft. If the motor is not turning, you will have some kind of electrical problem. If it is turning, then it is mechanical.

### **The motors sound louder and more labored in cold weather.**

As the temperature drops, we recommend that you reduce your slewing speed to the slowest slew rate. The cold causes the lubricants to get stiff in the gearboxes. This can make the high-speed gears resonate and sound screechy. Lowering the slew speed in winter will eliminate this. You might also want to add a drop or two of light machine oil to the center posts of the individual gears. Just remove the cover on the gearbox and add the oil drops. The noise is nothing to worry about. Refer to the section of this manual entitled: Slewing Your Mount in Below Freezing Temperatures.

### **The declination axis does not appear to be moving properly. How can I check it?**

Please refer to the appendix for the instruction sheet: "Characterizing the Dec Axis Motions," which explains how to use Maxim DL software to characterize your mount's performance.

### **When I press the E button on my keypad, it takes forever for the star to finally stop. Adjusting the backlash control using the keypad helped, but the problem is still there.**

First, the problem is most often caused by the worm and worm wheel not being in mesh (this is often the case when a used mount is purchased and the previous owner never ever adjusted the worm mesh or the mesh was altered during shipment). When the worm is out of mesh, it takes the motor many seconds to reverse the tooth contact from leading to trailing edge because it is running at the very slow sidereal rate. One could simply dial in an appropriate amount of RA backlash into the keypad in order to compensate for this. RA backlash compensation simply kicks the motor momentarily in the opposite direction at high speed until the opposite teeth have made contact and sidereal tracking can take place. The ideal solution is to adjust the worm backlash so that this delay does not occur. Please refer to the detailed information in the technical support section of our website.

### **I am experiencing trailed stars after a slew and apparently a high, variable backlash.**

Check to make sure that the spur gear that is attached to the end of the worm is not loose. A loose screw will indeed cause the axis to delay during reversal. In a few cases, we have seen that the set screw on this spur has backed off and needs to be retightened. If you have any doubts about where this worm and spur gear is in the scheme of things, call Astro-Physics and we will talk you through the procedure to check this.

Remember this: Any backlash or looseness in Dec will NOT cause trailed stars after a slew. That is because the DEC axis does not move once it gets to its new position, so no trailing is possible. So, if you are getting trailed stars for a short time, don't look for something in the Dec axis.

However, the RA axis WILL cause trailed stars after a slew if the spur gear is loose. That is because this axis must move at the sidereal rate immediately after getting to the new position. If the spur gear is loose on the worm shaft, it will turn slowly at the sidereal rate without imparting this motion to the worm itself (because it is slipping). At some point, the set screw will catch on the edge of the flat on the worm shaft and begin to drive the worm gear. So, this looks like classical backlash, when in fact it is not backlash at all, and all attempts at setting the gear mesh on the worm are futile to correct this lost motion.

When we get a chance, we will post a complete set of pictures on our web site showing how to check for this loose gear condition. Meanwhile, you can take the cover off the motor gearbox and acquaint yourself with the spur gears inside. Do not be afraid to move and wiggle things by hand to see how stuff works.

One more thing, sometimes a person will be absolutely certain that it is the Dec axis that is giving him a problem because the CCD program he is using shows some improper function in the Y axis, and he is absolutely certain that  $Y = Dec$ . After

much sending of equipment back and forth to our facility, it finally is determined that it was the other axis after all that had the problem. PLEASE, please make sure that you have identified the proper axis. In the case of any kind of motion problem like this, it would be really helpful if you removed your camera, inserted an eyepiece with crosshairs and actually looked to see what was happening. You can then identify exactly which direction, RA or DEC, is moving after a slew. Sometimes because of mix-ups in the CCD software (Maxim, for instance), the axes are identified backwards.

When you are trouble shooting, remember, RA is the only axis that must move at the sidereal rate and is the only axis that can trail a star if it is not moving correctly at that rate. The DEC axis does not move after a slew and will not trail a star except by a very slow long period drift due to polar misalignment, etc. It will not trail a star image EVEN if it has 10 degrees of backlash, so that analysis is definitely suspect.

### **I'm having a frustrating guiding problem with my mount and need to figure out my next steps.**

Your next step would be to remove the camera and place a high power eyepiece with crosshair reticle into the focuser. Then sit down and watch what happens to the guide star. With the eyepiece and reticle, you can see whether or not the mount is tracking smoothly and how the periodic error is manifesting itself. Yes, you will have periodic error, and any good CCD camera will pick it up to give you oval stars - that is a given. What you need to find out is whether this periodic error is within limits (+- 3.5 arc seconds for the 900GTO and +-2.5 arc seconds for the 1200GTO) and whether it is smoothly varying. You can also do some hand guiding using the 4 buttons on the keypad. It will tell you how responsive the mount is to your guiding inputs and may even show some hidden problems when you try to keep the star on the crosshairs.

Alternately, you can use PEMProAP (or the full version of PEMPro) to characterize your periodic error. It will tell you things like the peak value and the smoothness of the error.

You can also characterize your mount tracking and guiding abilities using the "Characterizing the Dec Motions" test outlined in the Technical Support section of our AP website and included in the back of this manual. Many times a problem guiding in RA can be the result of a Dec axis mechanical problem. Not knowing this, you will be forever chasing down the problem on the RA axis, and never reaching a solution. Characterizing your Dec Axis will at least show you that the mount reacts properly to the 4 guide directions. If it shows a problem area, then at least we will know how to fix it.

Once you know that the mount is tracking in a normal fashion with normal periodic error profile, you can go from there to begin setting up your guiding parameters. It is not a piece of cake to get a guider like the ST4 to work flawlessly. It is an art, but once you know that the mount responds properly to the guide inputs, it should be possible to set it up to work accurately.

## ***Additional Support***

For additional information regarding the 1200GTO, refer to the Technical Support Section of our website. We also encourage you to participate in the ap-gto user group. The members of this group are very knowledgeable about the operation of their mounts, CCD imaging and other related issues. The staff of Astro-Physics also participates and you will find a wealth of information in the archives. To find the group, link from User Groups in our website's sidebar.

**If any problems occur, please don't hesitate to contact Astro-Physics for assistance.**

We encourage you to submit your technical support questions directly to Astro-Physics by phone or e-mail: [support@astro-physics.com](mailto:support@astro-physics.com).

We may add additional troubleshooting tips to future versions of this manual or in a separate technical document. In such an instance, we would add this information to the Technical Support section of our website as well.

**ASTRO-PHYSICS, INC**  
11250 Forest Hills Road  
Machesney Park, IL 61115  
Telephone: (815)-282-1513  
Fax: (815)-282-9847  
[support@astro-physics.com](mailto:support@astro-physics.com)  
[www.astro-physics.com](http://www.astro-physics.com)

# STANDARD PIER ADAPTER OF THE 1200 MOUNT

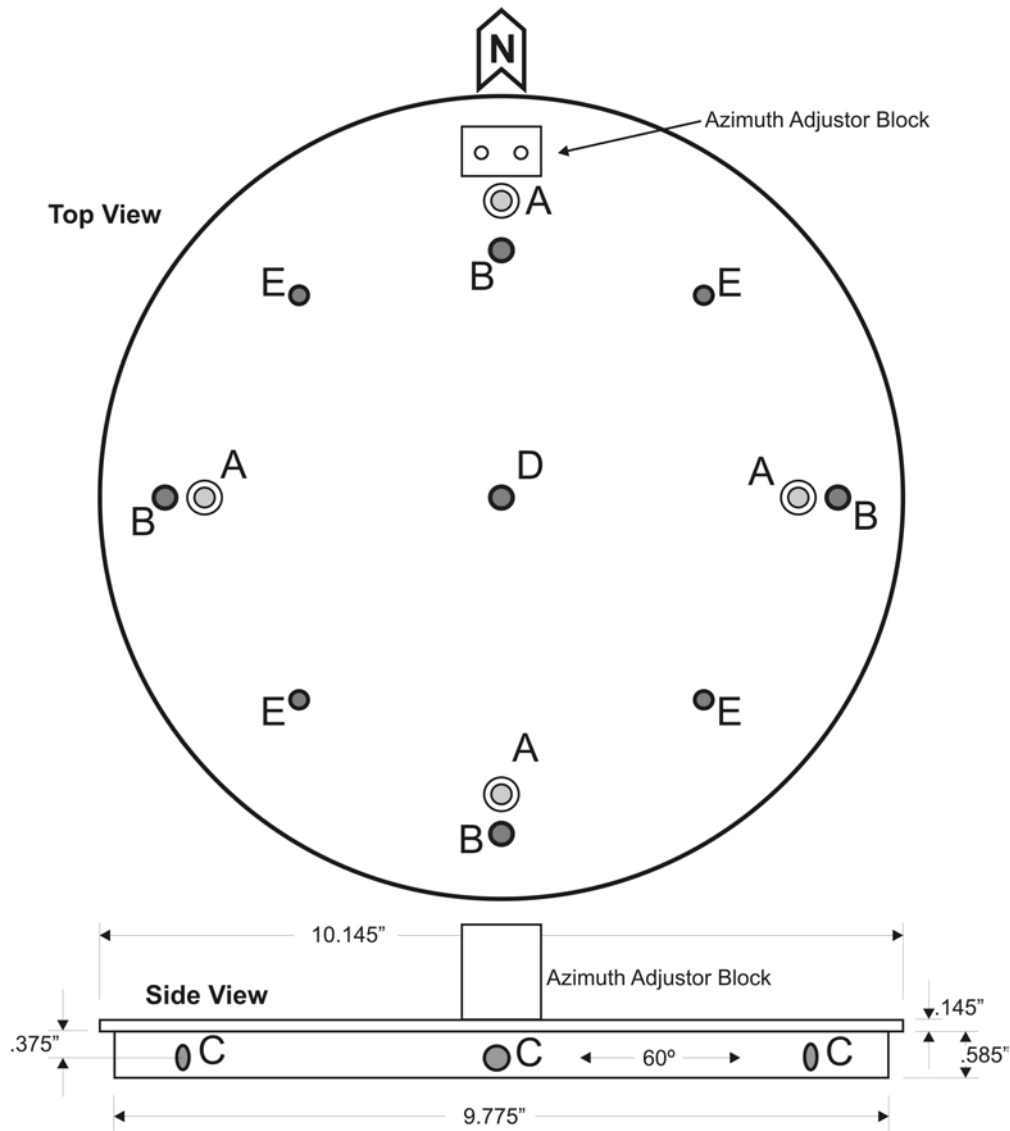

The 1200 series mount is designed to fit into our 10" outside diameter pier, which is available in several heights. The pier adapter of the 1200 mount shown above fits into the post (aluminum tube) of the pier assembly and is secured with six (6) 5/16-18 x 5/8" button head screws with washers at the location marked C.

If you want to make your own pier, you can either use these six (6) side holes (marked C) or you can use the four (4) countersunk through-holes (marked A) located on the top of the plate. You can also drill additional countersunk holes to fit your specific requirements.

- A. Countersunk through-holes for 1/4" cap screws – you can use these four (4) holes to attach the mount to a flat surface. These holes are on a 3.75" radius bolt-circle.
- B. The Polar Fork Base Assembly of the mount attaches to these locations with 4 Pier Adapter Knobs with washers.
- C. These six (6) 5/16-18 threaded holes are spaced every 60° on the circumference starting at North.
- D. The screw that is installed at this location is used to help center the rest of the mounting during assembly.  
NOTE: This is a specially machined screw – part # M12330M. Do not replace with a different screw!
- E. These holes are tapped 1/4-20 on a 3.615" radius bolt-circle, which allows you to attach a 900 Standard Pier Adapter (900SPA) or Flat Surface Adapter (900FSA) to your 10" pier.

# CLUTCH PLUG REPLACEMENT FOR 900 OR 1200 MOUNT

## Who needs clutch plug replacements?

If the clutch knobs of your 900 or 1200 mount are tightened down with excessive force, the plugs under the knobs may deform and splay out. This will cause your mount to feel very stiff and you will be unable to back off the pressure of the clutch knobs. Once this happens, the clutch plugs need to be replaced.

We have developed a tool, part #M0100, that will successfully remove the clutch plugs so that you can install new ones. If you prefer to make your own tool, we offer instructions in the Technical Support section of our website.

The part number of the clutch plugs is M12665-A. Please do not try to substitute your own clutch plugs since incorrect dimensions or composition of the material can impair the performance of your mount.

## What you will find in this package:

- A special screwdriver that has been modified by Astro-Physics, if you ordered it. This screwdriver is marked with masking tape. DO NOT REMOVE this tape. Instructions for making your own tool can be found below and in the Technical Support section of our website.
- Replacement clutch plugs (M12665-A).

## What you will need:

- ½ to 1 pound hammer
- A light machine oil (example: 3 in 1)

## Replacement of “old” Clutch Plugs

Removal of the old plugs will be done by, “hammering” the special “screwdriver” into the old plug. This will create a “driving” slot for the “screwdriver” blade.

## Please follow the steps below.

- Remove the clutch knob from the clutch plug hole.
- Insert the screwdriver into the clutch plug hole and press down firmly (make sure the guide point on the screwdriver is fully engaged in the center hole of the “old” clutch plug).
- Sharply hammer the screwdriver so as to drive its’ blade about 3/16 of an inch into the old plug. The masking tape on the screwdriver shank will provide a good reference for this 3/16” depth. The tape will be “level” with the top of the clutch plug hole when the correct depth has been achieved (see the illustration below).
- Maintaining a positive downward pressure, turn the screwdriver in a counter clockwise direction. This will cause the old clutch plug to “unscrew” from the clutch hole. You may need to use considerable turning force at first to get the old plug to start to “unscrew” itself.
- About 25 or so revolutions of the screwdriver will be needed to withdraw the plug completely.
- Place a “new” clutch plug down the hole.
- Place 2 – 3 drops of light machine oil down the hole.
- Replace clutch knob. Repeat above steps with the remaining seven “old” clutch knobs.

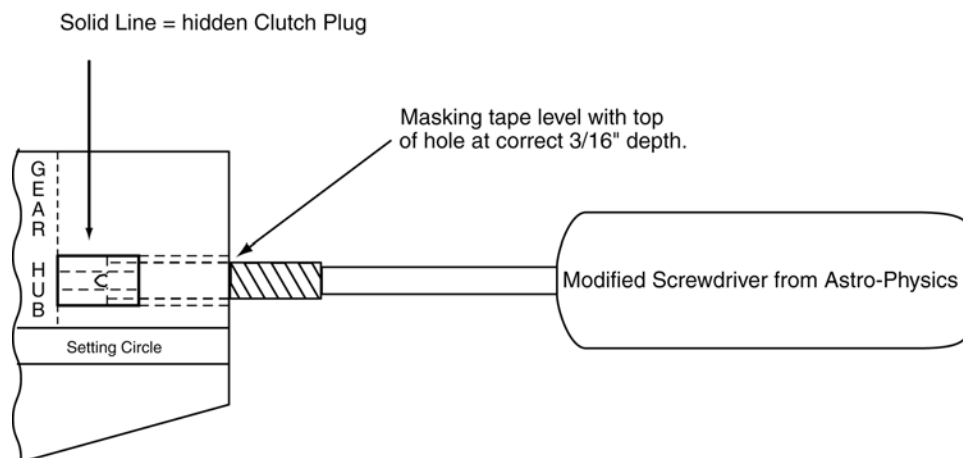

# CONSTRUCT YOUR OWN CLUTCH PLUG EXTRACTION TOOL

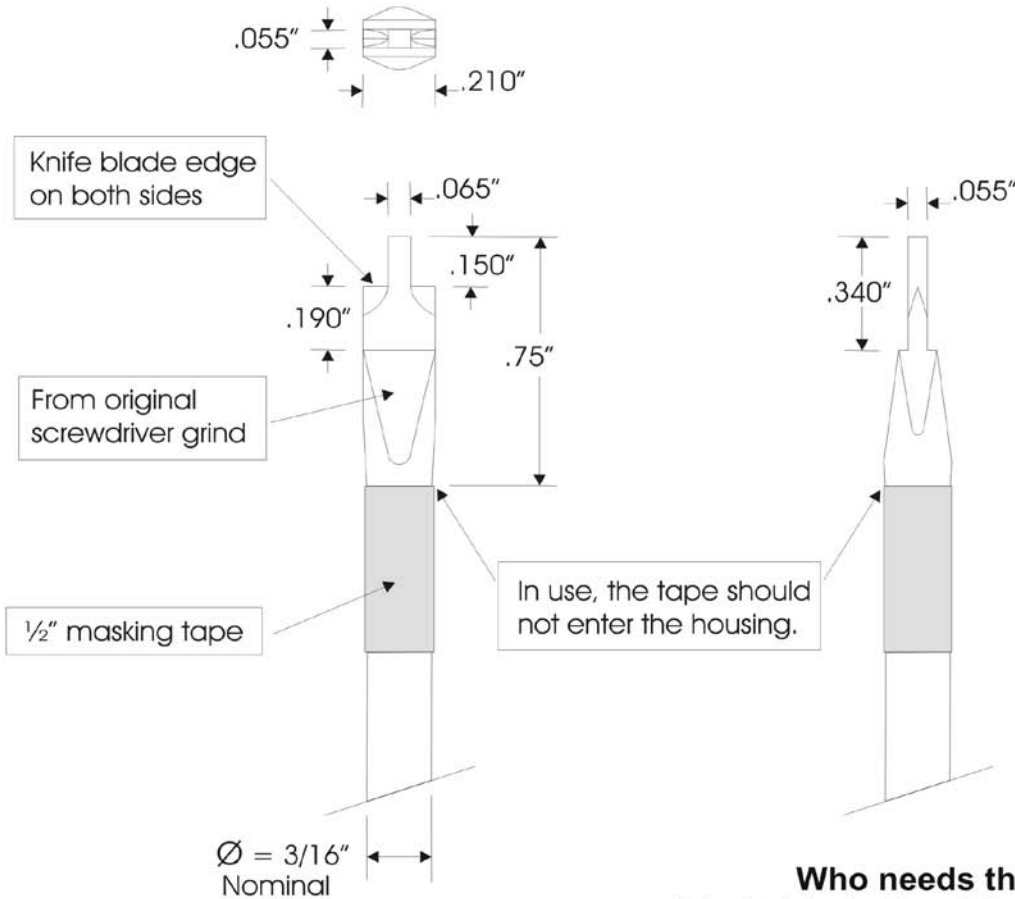

## Who needs this tool?

If the clutch knobs of your 900 or 1200 mount are tightened down with excessive force, the plugs under the knobs may deform and splay out. This will cause your mount to feel very stiff and you will be unable to back off the pressure of the clutch knobs. Once this happens, the clutch plugs need to be replaced.

### Solution:

We have developed a tool that will successfully remove the clutch plugs so that you can install new ones. We offer this diagram for those people who wish to make their own tool. We also offer the tool for sale as part #M0100. Please call Astro-Physics for pricing.

Call Astro-Physics to order the clutch plugs, part # M12665-A. Please **do not** try to substitute your own clutch plugs since incorrect dimensions or composition of the material can impair the performance of your mount. Instructions will be provided with the new clutch plugs and are also available from the Technical Support section of our website.

## Clutch Plug Extraction Tool For 900 and 1200 Mounts Tip Details

SCALE: 2 : 1

Dimensions  $\pm .0025$  inch

Date: 8-4-05

Drawn by: H.K.H.

Data by: W.A.P.

The tool is made from grinding the tip of standard 3/16 inch flat head screw-driver of 4 - 6 inch length.

# CHARACTERIZING THE DEC AXIS MOTIONS

These instructions explain how to use Maxim DL software as a tool for characterizing any problems with the Declination axis movements of your mount. However, Ray Gralak's [PulseGuide](#) software offers an easier and more extensive evaluation procedure. [PulseGuide](#) is available as a free download through our website.

## Step 1

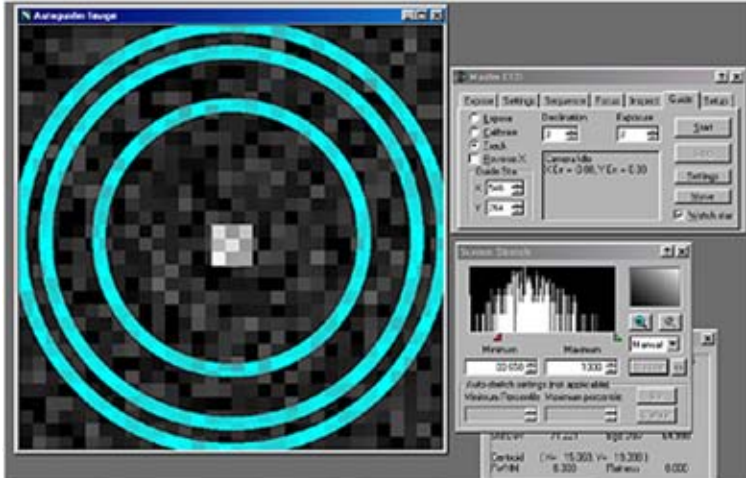

Acquire a reasonably bright guide star and begin guiding in RA only - turn off Dec guiding (note X and Y are switched on the Maxim parameter page, as of v3.07). Use a 1 second or faster refresh rate so you can see the motion of the guide star as you begin to move it around. Magnify the screen to 1600x and place the cursor in the middle as shown. Check to make sure that the mount is guiding adequately in RA, and that the guide star is not bouncing around due to poor seeing. Best results will be achieved when the RA guiding is 0.5 pixels average in RA.

## Step 2

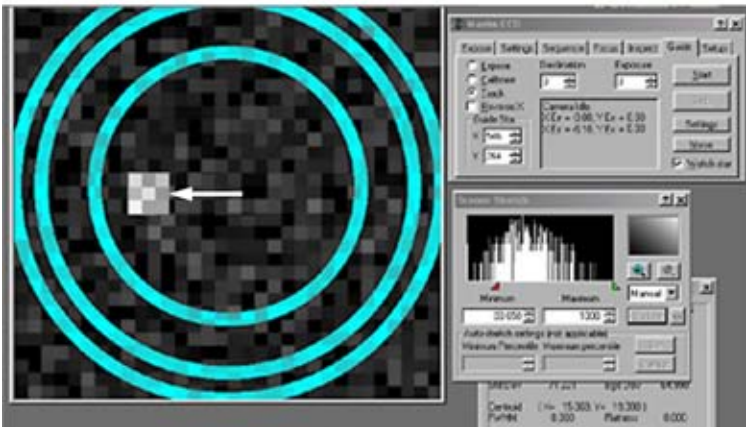

Put the keypad button rate at 0.5x. Press the keypad North button until the guide star has moved approximately 6 pixels from the center. Now press the South button in very short pulses and note which direction the star moves. It should move back toward the middle after a few button presses. It might move slightly up or down, or it might continue to move further away from the middle, or any combination. Please note exactly how far, and in which direction, the guide star moves (pixel position is displayed in the guide box at right in Maxim). Please allow a moment for the star to settle down after each button press.

## Step 3

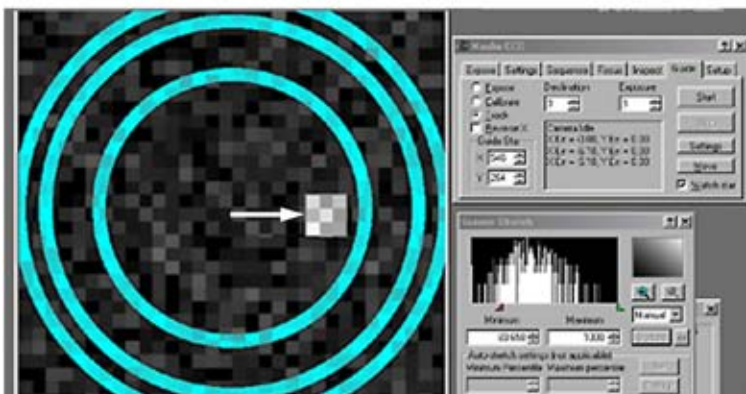

Press the South keypad button until the star has moved 6 pixels off the center in the opposite direction. Repeat Step 2 and note exactly the motion of the guide star as you move it with the pulsed motion at 0.5x.

You may wish to enable Track Log to record the numbers for further study. Please note on the log what you did at what time so the results will be useful later.

You have now characterized the Dec axis.

09-15-03



# ASTRO-PHYSICS MOUNTING PLATE FASTENER CHART

## Astro-Physics Mounting Plate Fastener Chart

A-P Part #	Description	Ships with:
<b>FP1500</b>	15" Flat Plate	(4) 1/4-20x5/8" SHCS [for mounting to 400, 900 or Mach1GTO] (4) M6-1.0x20mm SHCS [for mounting to 600E] (4) 1/4-20x3/4" SHCS [for mounting to 1200]
<b>FP1800</b>	18" Flat Plate	(6) 1/4-20x1" FHSCS [for mounting to 900 or 1200] (4) 1/4-20x1-1/4" FHSCS [Mach1GTO]
<b>DOVE08</b>	8" Dovetail Plate	(4) 1/4-20x1/2" SHCS [for mounting to 400] (4) M6-1.0x16mm FHSCS [for mounting to 600E] (4) 1/4-20x5/8" SHCS [for mounting to 900 or Mach1GTO, requires Q4047] (4) 10/32x3/4" SHCS [for mounting as Accessory Plate onto A-P rings]
<b>DOVE 15</b>	15" Dovetail Plate	(4) 1/4-20x1/2" FHSCS [for mounting to 400 or Mach1GTO] (4) M6-1.0x16mm FHSCS [for mounting to 600E] (4) 1/4-20x5/8" FHSCS [for mounting to 900 or 1200] (4) 10/32x3/4" SHCS [for mounting as Accessory Plate onto A-P rings]
<b>DOVELM2</b>	8.5" Dovetail Plate for Losmandy D Series Plate	(4) 1/4-20x5/8" SHCS [for mounting 400 or Mach1GTO] (4) M6-1.0x20mm SHCS [for mounting 600E] (2) 1/4-20x5/8" FHSCS [for mounting to 1200] ** (4) 1/4-20x3/4" SHCS [for mounting to 900 or 1200] **
<b>DOVELM16/S</b>	16" Dovetail Plate for Losmandy D Series Plate for 1200GTO - "S" version for 900 or Mach1GTO	(6) 1/4-20x1" SHCS [for mounting to 900 or 1200] (4) 1/4-20x7/8" SHCS [for Mach1GTO]
<b>DOVELM162</b>	16" Dovetail Plate for Losmandy D Series Plate for 900, 1200, Mach1GTO. Also for 3600GTO w/ SB3622	(6) 1/4-20x1" SHCS [for mounting to 900, 1200 or Mach1GTO (uses 4)] (1) 1/4-20x3/4" FHSCS [opt. 900 or 1200 for end positions] (4) 1/4-20x3/4" SHCS [for SB3622 in side-by-side configuration]
<b>900RP</b>	15" Ribbed Plate for 900 or Mach1GTO	(6) 1/4-20x1" FHSCS [for mounting to 900] (4) 1/4-20x1-1/4" FHSCS [for mounting Mach1GTO]
<b>1200RP15</b>	15" Ribbed Plate for 1200	(6) 1/4-20x3/4" SHCS [for mounting to 1200]
<b>1200RP</b>	24" Ribbed Plate for 1200	(6) 1/4-20x1" SHCS [for mounting to 1200]
<b>Q4047</b>	900/Mach1GTO Adapter for use with DOVE08	(6) 1/4-20x5/8" FHSCS [for mounting to 900] (4) 1/4-20x1" FHSCS [for mounting to Mach1GTO]
<b>SB0800 OR SB1000 OR SB1500</b>	Sliding Bar	(2) 1/4-20X1/2" SHCS (2) Acorn Nuts (2) 1/4-20 Nuts (2) 1/4-20x3/8" SHCS (1) 10-32x5/8" FHSCS (1) 10-32 Nut
<b>SBD12</b>	12" Sliding Bar for the Losmandy D-Series Plates	(4) 1/4-20x1" low profile SHCS [for attaching the LMAPBLOCKS] (4) 1/4-20x1-1/4" FHCS [for attaching directly to 47RING] (4) 1/4-20x1/2" low profile SHCS (3) 1/4-20x3/8" SHCS (2) 1/4-20x7/8" SHCS
<b>LT2APM</b>	Losmandy Tripod to Astro-Physics Mount Adapter Plate	(3) 5/16-18x5/8" SHCS (4) 1/4-20x5/8" SHCS (4) 1/4-20x1" SHCS (3) 3/8-16x3/4 SHCS
<b>CBAPT, TRAYSB &amp; TRAYSB1</b>	Control Box Adapter, Bi-Level Support Bar & Single Level Support Bar	(1) 1/4-20X3/4" FHSCS (1) 1/4-20X1" FHSCS (1) 5/16-18X1" BHSCS (2) 5/16-18X3/4" BHSCS
<b>DOVE3622</b>	22" Dovetail Saddle Plate for 3600GTO	(6) 3/8-16x1" SHCS (4) 3/8-16x1-1/2" SHCS
<b>SB3622</b>	Dovetail Sliding Bar for DOVE3622	(2) 3/8-16x1/2" low profile SHCS (4) 1/4-20x1" SHCS

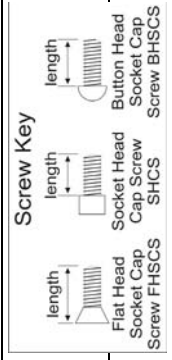

\*\* DOVELM2 may also be attached to 900 mount with (1) 1/4-20x5/8" FHSCS and (1) 1/4-20x3/4 SHCS